



BERLI[®]
MACCHINE AGRICOLE

**TA/K
TA/LI
TA/L**



Trinciargini per trattori da 20 a 60 HP



In-line and offset mulchers for tractors from 20 to 60 HP



Böschungsmulcher für Traktoren von 20 bis 60 PS



Broyeurs multifonctions pour tracteurs de 20 a 60 CV



Trituradoras de laderas para tractores de 20 a 60 CV



L'esperienza di 60 anni nel settore delle macchine agricole permette alla ditta Berti di offrire alla sua vasta clientela una gamma completa di attrezzature tecnologicamente avanzate al servizio di un'agricoltura sempre più esigente e specializzata. La qualità dei prodotti fin dalla materia prima, la volontà di soddisfare sempre e prima di tutto le esigenze della clientela, la robustezza, l'affidabilità, hanno dato vita al largo consenso che queste macchine hanno ricevuto in tutto il mondo.



The experience of 60 years in the manufacturing manufacturing of farm implements makes it possible for Berti Company to offer a complete range of technologically advanced mulchers and shredders, to serve a more and more demanding and specialized agriculture.

The high quality, the sturdiness and the reliability of the products, the will to satisfy always the customer's requirement are the reasons of the large success enjoyed by these implements worldwide.





Die Firma Berti hat 60 Jahre Erfahrung auf dem Gebiet der Landwirtschaftsmaschinen und ist also imstande, ihren zahlreichen Kunden eine komplette Palette von technologisch fortgeschrittenen Landwirtschaftsausrüstungen zu Verfügung zu stellen.

Die Produktqualität, gekennzeichnet durch die Wahl von Rohstoffen erster Klasse, die Beständigkeit und die Zuverlässigkeit der Maschinen, hat die Firma in die Lage gesetzt, diese in der ganzen Welt einzusetzen.

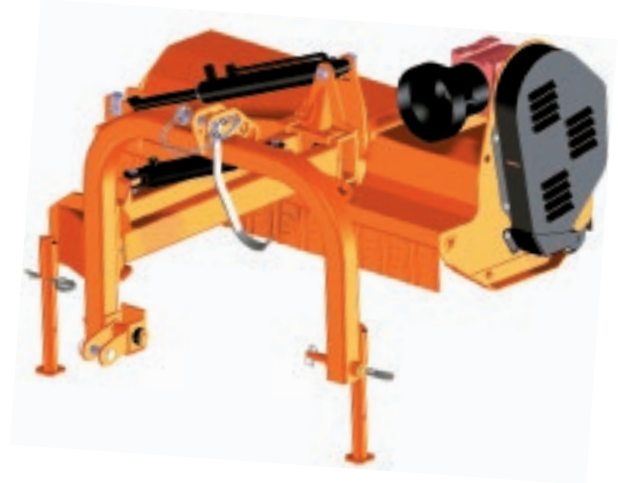

L'expérience acquise au cours de 60 ans de la machine agricole permet à la firme Berti d'offrir à ses nombreux clients une gamme complète d'équipements technologiquement à l'avant-garde au service

d'une agriculture exigeante et professionnelle. La qualité des produits à partir de la matière première, la volonté de satisfaire surtout les exigences de la clientèle, la résistance et la fiabilité ont permis à nos machines d'obtenir un accueil très favorable dans le monde entier.



La experiencia de 60 años en el sector de las máquinas agrícolas ha permitido a la empresa Berti ofrecer a sus clientes una gama completa de equipos tecnológicamente avanzados para una agricultura cada vez más especializada. Gracias a la robustez y a la fiabilidad de los productos y a una calidad que se busca incluso en las materias primas empleadas, unido a la voluntad de satisfacer siempre y en primer lugar las exigencia de los clientes, Berti se ha hecho famosa en todo el mundo.

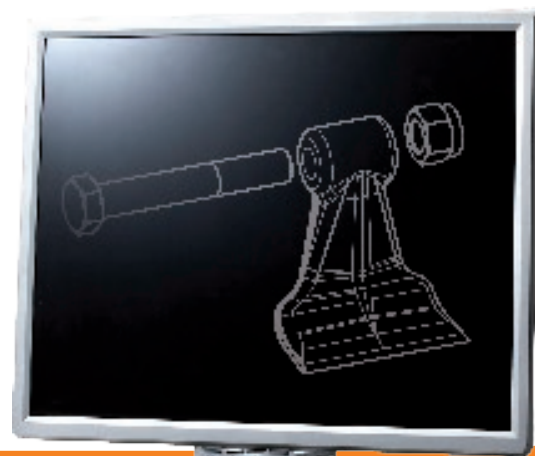

TA/K

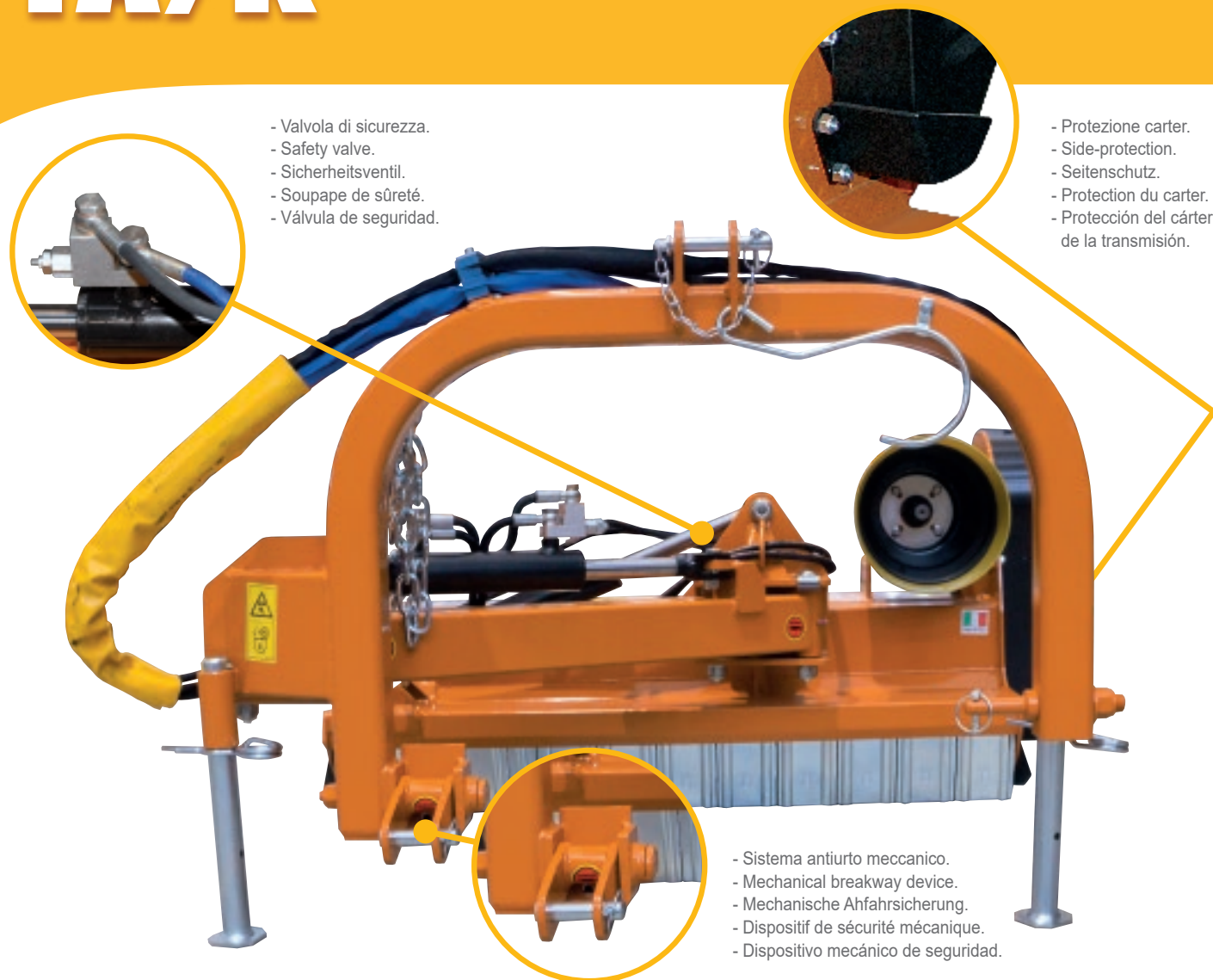



- Valvola di sicurezza.
- Safety valve.
- Sicherheitsventil.
- Soupape de sûreté.
- Válvula de seguridad.

- Protezione carter.
- Side-protection.
- Seitenschutz.
- Protection du carter.
- Protección del cárter de la transmisión.

- Sistema antiurto meccanico.
- Mechanical breakway device.
- Mechanische Ahfahrsicherung.
- Dispositif de sécurité mécanique.
- Dispositivo mecánico de seguridad.

 Trinciatrice compatta multiuso, da applicare a trattori con potenza compresa tra 25 e 50 HP. Adatta a lavorare sia posteriormente che lateralmente al trattore. E' consigliata per erba, residui vegetali, cespugli e sarmenti di \varnothing 2 cm. Ideale per la pulizia di parchi, aree verdi, giardini, bordi di strade, su fossati, argini e terreni inclinati in genere.









 Broyeur d'acotement multifonctions pour broyer l'herbe, les déchets végétaux, les buissons et les sarments allant jusqu'à \varnothing 2 cm, indiqué pour tracteurs de 25 à 50 CV. Il est idéal pour le nettoyage des espaces verts, des jardins, des rebords des routes, des fossés, des digues et des terrains inclinés.

 Offset / in-line mulcher for grass, residue of vegetables, bushes and pruning up to \varnothing 2 cm, suited for tractors from 25 to 50 HP. Ideal for clearing green areas, gardens, slopes, ditches, banks of watercourses, road side banks.

 Desbrozadora indicada para la trituración de hierba, residuos vegetales, arbustos y restos de poda (hasta 2 cm \varnothing), para tractores de 25 a 50 CV. Ideal para parques, áreas verdes, jardines, cunetas y terrenos en pendiente en general.

 Universalgerät für Heckanbau, für seitliches Mulchen oder hinter dem Schlepper für Gras, Vegetation, Reisig und Äste bis \varnothing 2 cm für Randstreifen, für Wassergräben und Böschungen, für Traktoren von 25 bis 50 PS.

Il trattore deve essere dotato di almeno n.2 prese d'olio a doppio effetto / The tractor has to be equipped with n. 2 double effect oil plugs / Der Traktor muss mit 2 doppelwirkenden Hydraulikanschlüssen ausgestattet sein / Le tracteur doit être équipé avec au moins 2 prises d'huile à double effet / El tractor deberá estar equipado con al menos dos enchufes hidráulicos con válvula de doble efecto.

Mod.									
	cm	Min HP	Max	n°	n°	n°	PTO	min	max
TA/K 115	115	25	50	32	64	2	540	300	345
TA/K 125	125	25	50	34	68	2	540	310	355
TA/K 145	145	25	50	40	80	2	540	330	375



- Sistema flottante con limitatore.
- Floating device, with limiter.
- Schwimmstellung-System mit Hubbegrenzer.
- Système flottante avec limiteur.
- Sistema de enganche flotante con limitador.

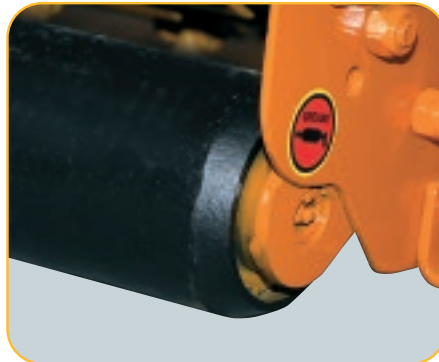

- Rullo livellatore posteriore autopulente, regolabile in altezza.
- Height adjustable self-cleaning levelling roller.
- Einstellbare und selbstreinigende Stützwalze.
- Rouleau palpeur autonettoyant, réglable en hauteur.
- Rodillo trasero autolimpiante y regulable en altura.



- Slitte d'appoggio antiusura.
- Skids of anti-wearing steel.
- Jeu patins anti-usure.
- Satz Kufen mit Anti-Verschleißmaterial.
- Patines de acero reforzado anti-desgaste.



- Tenditore automatico delle cinghie.
- Full automatic belts adjuster.
- Automatische Riemenspannung.
- Tendeur automatique des courroies.
- Tensor automático de las correas.



- Albero cardanico rinforzato.
- Hardened PTO drive shaft.
- Verstärkte Gelenkwelle.
- Cardan à profil renforcé.
- Eje de TDF reforzado.

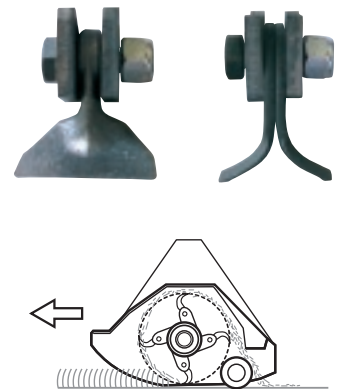

OPTIONALS

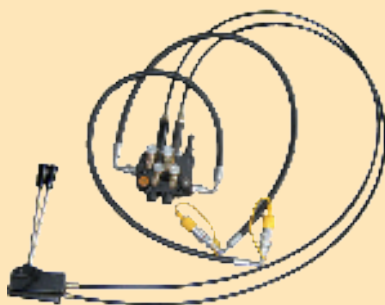

- Distributore a doppio effetto con leve e cavi flessibili.
- Double effect distributor with levers and with wire-cables.
- Doppelwirkendes Steuerventil mit Hebeln und Bowdenzügen.
- Distributeur double effet à leviers avec téléflexibles en cabine.
- Distribuidor de doble efecto con accionamiento por tele-flexibles.



- Albero cardanico doppio omocinetico.
- Double Wide-Angle drive shaft.
- Doppel-Weitwinkel Gelenkwelle.
- Cardan double homocinétique.
- Cardan doble homocinetico.

TA/LI



- Attacco 3° punto con snodo oscillante.
- 3-point linkage with floating link.
- Dreipunktbock mit Schwimmstellung System.
- Attelage à 3 points avec système flottante.
- Enganche a los tres puntos del tractor con enganche flotante.

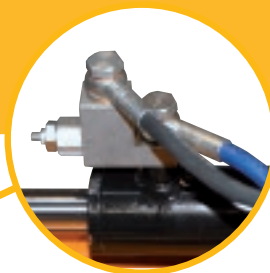

- Valvola di sicurezza.
- Safety valve.
- Sicherheitsventil.
- Soupape de sûreté.
- Válvula de seguridad.



- Protezione carter.
- Side-protection.
- Seitenschutz.
- Protection du carter.
- Protección del cárter de la transmisión.



Trinciatrice compatta multiuso, da applicare a trattori con potenza compresa tra 35 e 60 HP. Adatta a lavorare sia posteriormente che lateralmente al trattore. E' consigliata per erba, residui vegetali, cespugli e sarmenti di \varnothing 2-3 cm., Ideale per la pulizia di parchi, aree verdi, giardini, bordi di strade, su fossati, argini e terreni inclinati in genere.



Broyeur d'accotement compact multifonctions pour l'herbe, les déchets végétaux, les buissons et les sarments allant jusqu'à \varnothing 2-3 cm, indiqué pour tracteurs de 35 à 60 CV. Il est idéal pour les parcs, les espaces verts, les jardins, le rebord des routes, les fossés, les digues et les terrains inclinés.



Compact offset / in-line mulcher for grass, residue of vegetables, bushes and pruning up to \varnothing 2-3 cm., suited for tractors from 35 to 60 HP. Ideal for parks, green areas, gardens, slopes, ditches, banks of watercourses.



Desbrozadora compacta indicada para la trituración de hierba, residuos vegetales, arbustos y restos de poda (hasta 2-3 cm \varnothing), para tractores de 35 a 60 CV. Ideal para parques, áreas verdes, jardines, cunetas y terrenos en pendiente en general.



Heck-und Seitenmulcher für Gras, Vegetation, Reisig und Äste bis \varnothing 2-3 cm. für Traktoren von 35 bis 60 PS. Es eignet sich für Parks, Garten, Wiesen, Böschungen und Wassergräben.

Il trattore deve essere dotato di almeno n.2 prese d'olio a doppio effetto / The tractor has to be equipped with n. 2 double effect oil plugs / Der Traktor muss mit 2 doppelwirkenden Hydraulikanschlüssen ausgestattet sein / Le tracteur doit être équipé avec au moins 2 prises d'huile à double effet / El tractor deberá estar equipado con al menos dos enchufes hidráulicos con válvula de doble efecto.

Mod.									
	cm	Min	Max	n°	n°	n°	PTO	min	max
TA/LI 135	135	35	60	12	36	3	540	435	515
TA/LI 145	145	35	60	14	42	3	540	445	525
TA/LI 160	160	35	60	14	42	3	540	460	540



- Sistema flottante con limitatore.
- Floating device, with limiter.
- Schwimmstellung-System mit Hubbegrenzer.
- Système flottante avec limiteur.
- Sistema de enganche flotante con limitador.



- Rullo livellatore posteriore autopulente, regolabile in altezza.
- Height adjustable self-cleaning levelling roller.
- Einstellbare und selbstreinigende Stützwalze.
- Rouleau palpeur autonettoyant, réglable en hauteur.
- Rodillo trasero autolimpiable y regulable en altura.

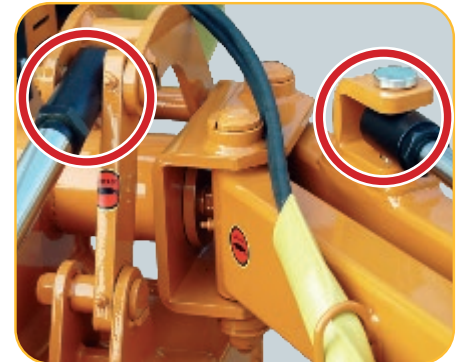

- Martinetti regolabili.
- Adjustable cylinders.
- Einstellbare hydr. Zylinder.
- Vérins réglables.
- Cilindros hidráulicos con extensión ajustable.



- Albero cardanico rinforzato.
- Hardened PTO drive shaft.
- Verstärkte Gelenkwelle.
- Cardan à profil renforcé.
- Eje de TDF reforzado.

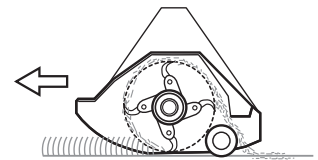

OPTIONALS



- Sistema antishock BERTI*.
- Exclusive BERTI Anti-Shock Device*.
- Anti-Schock System BERTI*.
- Système antichoc exclusif BERTI*.
- Dispositivo antichoque exclusivo de Berti*.



- Slitte d'appoggio antiusura.
- Skids of anti-wearing steel.
- Satz Kufen mit Anti-Verschleißmaterial.
- Jeu patins anti-usure.
- Patines de acero reforzado anti-desgaste.



- Albero cardanico doppio omocinetico.
- Double Wide-Angle drive shaft.
- Doppel-Weitwinkel Gelenkwelle.
- Cardan double homocinétique.
- Cardan doble homocinético.

TA/L

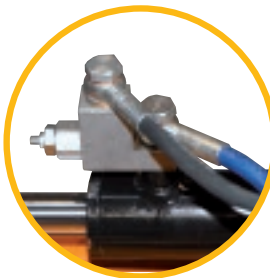
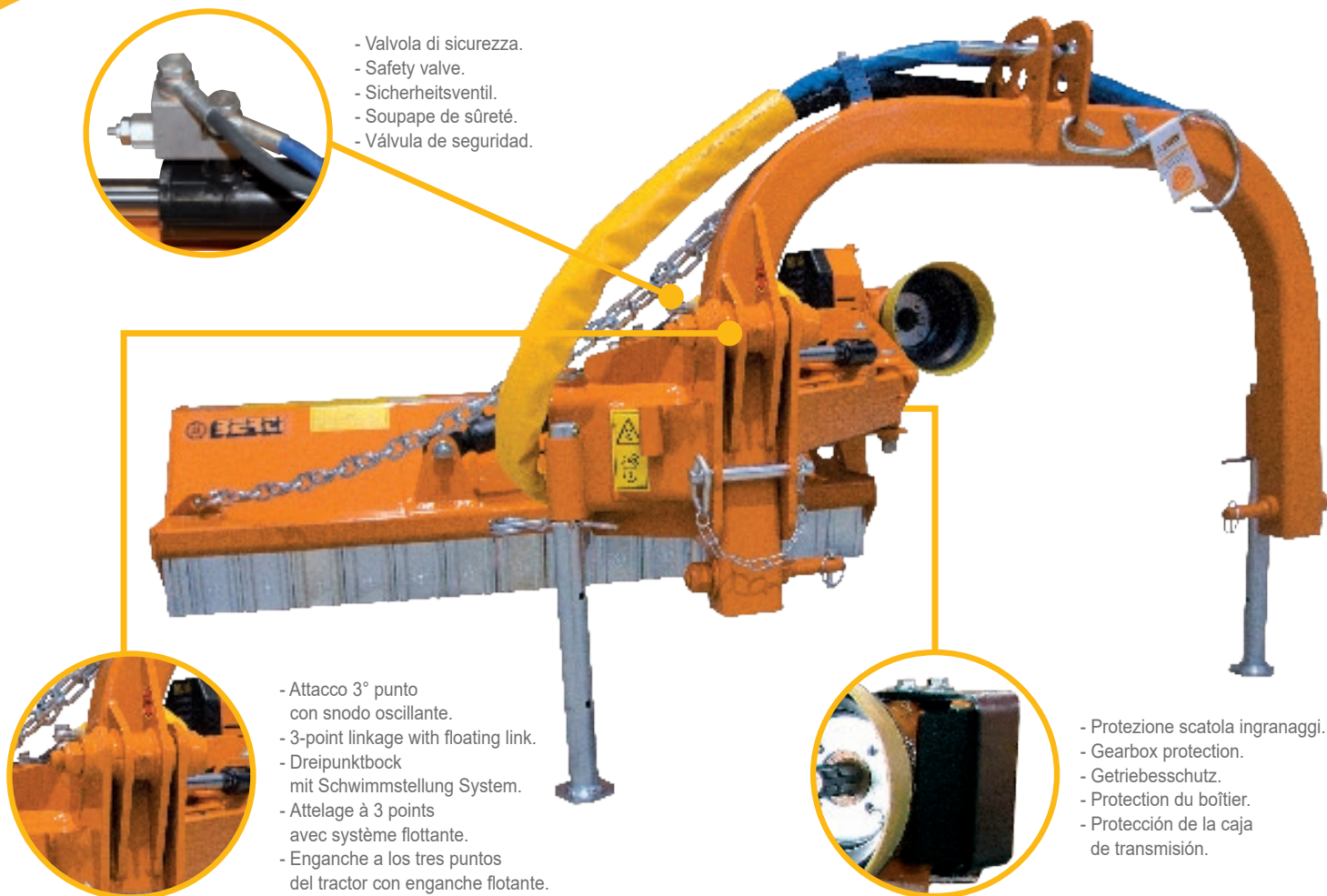

- Valvola di sicurezza.
- Safety valve.
- Sicherheitsventil.
- Soupape de sûreté.
- Válvula de seguridad.



- Attacco 3° punto con snodo oscillante.
- 3-point linkage with floating link.
- Dreipunktbock mit Schwimmstellung System.
- Attelage à 3 points avec système flottante.
- Enganche a los tres puntos del tractor con enganche flotante.

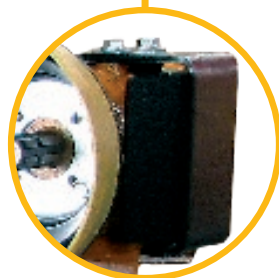

- Protezione scatola ingranaggi.
- Gearbox protection.
- Getriebeschutz.
- Protection du boîtier.
- Protección de la caja de transmisión.



Trinciatrice compatta multiuso, da applicare a trattori con potenza compresa tra 35 e 60 HP. Adatta a lavorare sia posteriormente che lateralmente al trattore. E' consigliata per erba, residui vegetali, cespugli e sarmenti di \varnothing 2-3 cm., Ideale per la pulizia di parchi, aree verdi, giardini, bordi di strade, su fossati, argini e terreni inclinati in genere.



Broyeur d'accotement compact multifonctions pour broyer l'herbe, les déchets végétaux, les buissons et les sarments allant jusqu'à \varnothing 2-3 cm, indiqué pour tracteurs de 35 à 60 CV. Il est idéal pour les parcs, les espaces verts, les jardins, le rebord des routes, les fossés, les digues et les terrains inclinés.



Compact offset / in-line mulcher for grass, residue of vegetables, bushes and pruning up to \varnothing 2-3 cm., suited for tractors from 35 to 60 HP. Ideal for parks, green areas, gardens, slopes, ditches, banks of watercourses.



Desbrozadora compacta indicada para la trituración de hierba, residuos vegetales, arbustos y restos de poda (hasta 2-3 cm \varnothing), para tractores de 35 a 60 CV. Ideal para parques, áreas verdes, jardines, cunetas y terrenos en pendiente en general.



Heck und Seitenmulcher für Gras, Vegetation, Reisig und Ästen bis \varnothing 2-3 cm. für Traktoren von 35 bis 60 PS. Es eignet sich für Parks, Garten, Wiesen, Böschungen und Wassergräben.

Il trattore deve essere dotato di almeno n.2 prese d'olio a doppio effetto / The tractor has to be equipped with n. 2 double effect oil plugs / Der Traktor muss mit 2 doppelwirkenden Hydraulikanschlüssen ausgestattet sein / Le tracteur doit être équipé avec au moins 2 prises d'huile à double effet / El tractor deberá estar equipado con al menos dos enchufes hidráulicos con válvula de doble efecto.

Mod.									
	cm	Min HP	Max	n°	n°	n°	PTO	min	max
TA/L 115	115	35	60	10	30	3	540	395	485
TA/L 135	135	35	60	12	36	3	540	425	505
TA/L 145	145	35	60	14	42	3	540	450	530



- Sistema flottante con limitatore.
- Floating device, with limiter.
- Schwimmstellung-System mit Hubbegrenzer.
- Système flottante avec limiteur.
- Sistema de enganche flotante con limitador.



- Rullo livellatore posteriore autopulente, regolabile in altezza.
- Height adjustable self-cleaning levelling roller.
- Einstellbare und selbstreinigende Stützwalze.
- Rouleau palpeur autonettoyant, réglable en hauteur.
- Rodillo trasero autolimpiable y regulable en altura.

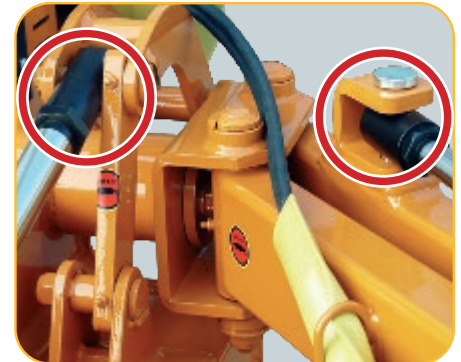

- Martinetti regolabili.
- Adjustable cylinders.
- Einstellbare hydr. Zylinder.
- Vérins réglables.
- Cilindros hidráulicos con extensión ajustable.



- Albero cardanico rinforzato.
- Hardened PTO drive shaft.
- Verstärkte Gelenkwelle.
- Cardan à profil renforcé.
- Eje de TDF reforzado.

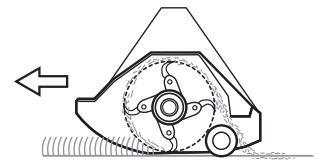

OPTIONALS



- Sistema antishock BERTI*.
- Exclusive BERTI Anti-Shock Device*.
- Anti-Schock System BERTI*.
- Système antichoc exclusif BERTI*.
- Dispositivo antichoque exclusivo de Berti*.



- Slitte d'appoggio antiusura.
- Skids of anti-wearing steel.
- Satz Kufen mit Anti-Verschleißmaterial.
- Jeu patins anti-usure.
- Patines de acero reforzado anti-desgaste.



- Albero cardanico doppio omocinetico.
- Double Wide-Angle drive shaft.
- Doppel-Weitwinkel Gelenkwelle.
- Cardan double homocinétique.
- Cardan doble homocinético.

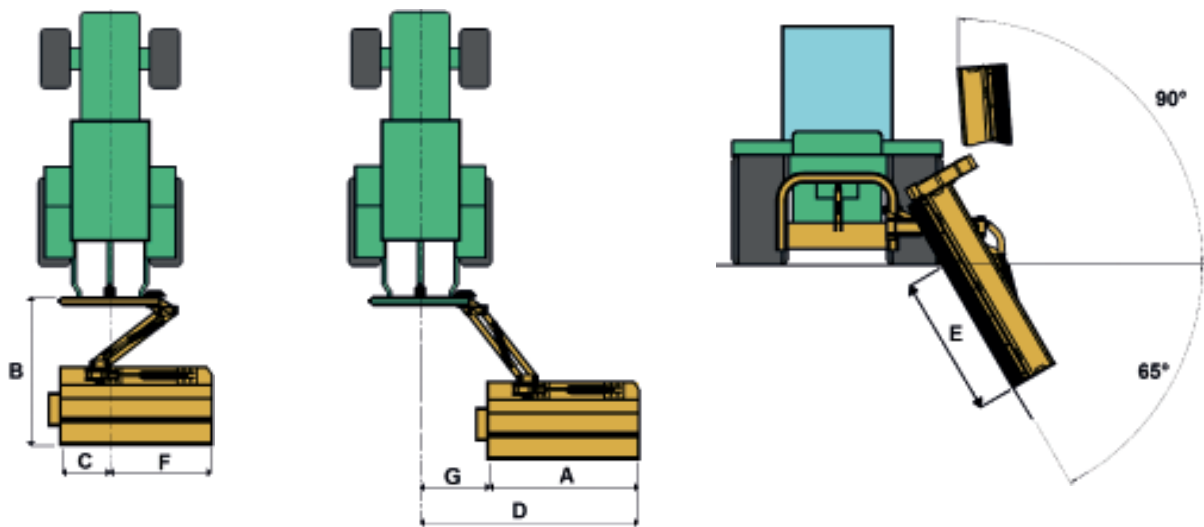

TA/K

Mod.	A	B	C	D	E	F	G
	cm	cm	cm	cm	cm	cm	cm
TA/K 115	115	120	51	157	73	65	42
TA/K 125	125	125	60	170	83	65	45
TA/K 145	145	125	60	190	103	85	45

TA/LI

Mod.	A	B	C	D	E	F	G
	cm	cm	cm	cm	cm	cm	cm
TA/LI 135	135	157	61	195	92	74	60
TA/LI 145	145	157	61	205	102	84	60
TA/LI 160	160	157	61	220	117	99	60

TA/L

Mod.	A	B	C	D	E	F	G
	cm	cm	cm	cm	cm	cm	cm
TA/L 115	115	157	26	215	110	89	100
TA/L 135	135	157	26	235	130	109	100
TA/L 145	145	157	26	245	140	119	100

***ANTI-SHOCK BERTI**

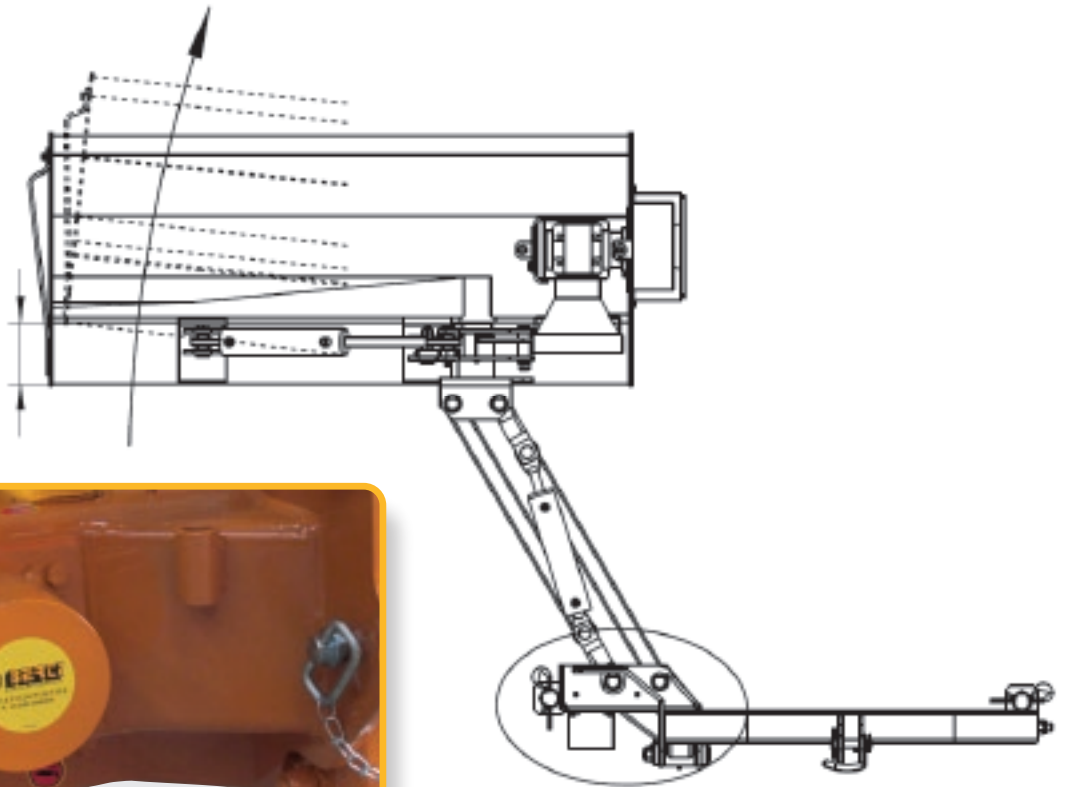



bertima.it

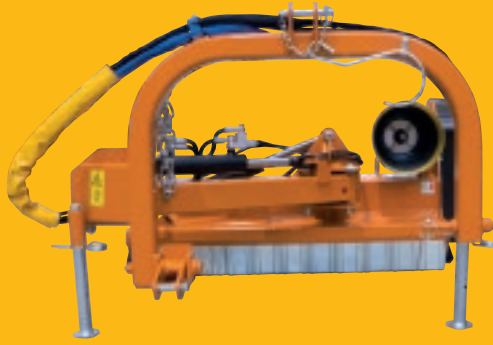

TA/K



TA/LI



TA/L

Le illustrazioni e i dati del presente catalogo sono indicative e non vincolanti per il costruttore • All pictures and data above are indicative only and not binding for the manufacturer • Alle in diesem Katalog enthaltenen Angaben und Zeichnungen sind annähernd und unverbindlich • Toutes les données insérées dans ce catalogue ont été indiquées seulement à titre de renseignement • Las fotografías y los datos mostrados son meramente indicativos y podrían ser variados sin previo aviso por el fabricante.



BERTI[®]
MACCHINE AGRICOLE



Via Musi, 1/A-3-4 - 37042 Caldiero (VR) ITALY
Tel. +39.045.6139711 - Fax +39.045.6150251
info@bertima.it



 **MADE IN ITALY**