



BERLI[®]
MACCHINE AGRICOLE

ERPICI ROTANTI

POWER HARROWS

KREISELEGGEN

HERSES ROTATIVES

GRADAS ROTATIVAS



Erpici rotanti per trattori da 20 a 300 HP



Power harrows for tractors from 20 to 300 HP



Kreiseleggen für Traktoren von 20 bis 300 PS



Herses rotatives pour tracteurs de 20 à 300 CV





Gradas rotativas para tractores de 20 a 300 CV

IONIO













 Erpice rotante per trattori da 20 a 40 HP. Ideale per la preparazione del terreno per la semina negli orti, vivai, serre e frutteti.

 Power harrow for tractors between 20 and 40 HP. Suited to the preparation of soils, seedbeds in gardens, nurseries, greenhouses and orchards.

 Kreiselegge für Schlepper von 20 bis 40 PS. Es eignet für die Bodenvorbereitung von Kleinflächen, sowie Gemüsegärten, Baumschulen, Gewächshäuser und Obstbau.

 Herse rotative pour tracteurs entre 20 et 40 CV. Indiqué pour travailler le sol afin de préparer les terrains pour l'ensemencement dans les potagers, pépinières, serres, vergers.

 Grada rotativa para tractores desde 20 hasta 40 CV. Apta para la preparación de la tierra para la siembra en huertos, invernaderos y frutales.

Mod.																				
	cm	Min	Max	cm	cm	n°	n°	Kg	Kg	Kg	Kg	cm	cm	cm	cm	cm	cm	cm		
IONIO 90	87	20	40	90	22	4	4 + 4	195	215	-	265	90	117	87	72					
IONIO 110	107	20	40	110	22	5	6 + 4	230	245	245	290	110	117	87	72					
IONIO 130	127	25	40	130	22	6	6 + 6	255	275	275	315	130	117	87	72					
IONIO 150	147	30	40	150	22	7	8 + 6	285	305	305	335	150	117	87	72					
IONIO 170	167	35	40	170	22	8	8 + 8	315	335	335	385	170	117	87	72					

* + 20 cm. con rullo a rete - with net roller - mit Gitterwalze - avec rouleau à grille - con rodillo reticular



- Rullo a spuntoni.
- Spike roller.
- Zinkenwalze.
- Rouleau à pointes.
- Rodillo con puntas.



- Rullo a gabbia.
- Cage roller.
- Stabwalze.
- Rouleau cage.
- Rodillo de barras.



- Rullo a rete.
- Net roller.
- Gitterwalze.
- Rouleau à grille.
- Rodillo reticular.

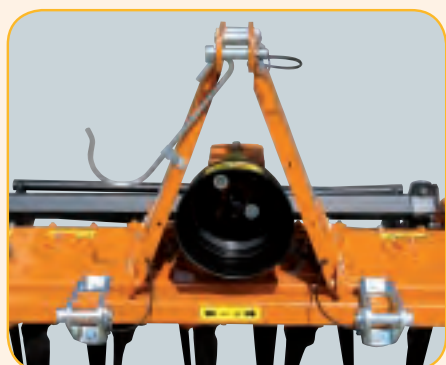

- Attacco ai tre punti, cat. I.
- 3 point linkage cat. I.
- Dreipunktbock, Kat. I.
- Attelage à 3 points, Cat. I.
- Enganche a los 3 puntos, cat. I.



- Riduttore a una velocità PTO 540 g/min - giri rotore: 350.
- Single-speed gearbox, PTO 540: 350 rpm.
- Zapfwelle 540 U/Min., mit 1-Stufe, Rotordrehzahlen: 350 U/Min.
- Boîtier mono vitesse à 540 pdf: 350 T/min.
- Reductor con una velocidad, T.d.f. 540: 350 rpm.

OPTIONALS



- Barra di affinamento con montaggio posteriore o anteriore.
- Front or rear levelling bar.
- Vordere oder hintere Krümelschiene.
- Kit lame niveleuse arrière ou avant.
- Barra niveladora posterior o anterior.



- Seminatrice a spallio per prato.
- Flying seeder machine for lawn.
- Drillmaschine für Wiese.
- Sémoir centrifuge.
- Sembradora centrifuga.

TIRRENO



Erpice rotante per trattori da 30 a 70 HP. Ideale per la preparazione del terreno per la semina sia nei campi aperti che negli orti, vivai, serre e frutteti.



Herse rotative pour tracteurs entre 30 et 70 CV. Indiqué pour travailler le sol afin de préparer les terrains pour l'ensemencement dans les espaces ouverts mais aussi les potagers, pépinières, serres, vergers.



Power harrow for tractors between 30 and 70 HP. Suited to the preparation of soils in open fields, gardens, nurseries, greenhouses and orchards.



Grada rotativa para tractores desde 30 hasta 70 CV. Apta para la preparación de la tierra para la siembra en campos abiertos, huertos y frutales.



Kreiselegge für Schlepper von 30 bis 70 PS. Es eignet für die Bodenvorbereitung in Großflächen, sowie in Gemüsegärten, Baumschulen, Gewächshäuser und Obstbau.

Mod.																
	cm	Min Max	cm	cm	n°	n°	Kg	Kg	Kg	Kg	Kg	Kg	A*	B	C	
TIRRENO 110	107	25 70	111	26	5	6 + 4	-	280	295	-	335	111	122	100		
TIRRENO 130	127	25 70	131	26	6	6 + 6	395	310	320	-	370	131	122	100		
TIRRENO 150	147	30 70	151	26	7	8 + 6	415	345	355	-	400	151	122	100		
TIRRENO 170	167	35 70	171	26	8	8 + 8	455	380	385	-	435	171	122	100		
TIRRENO 190	187	40 70	191	26	9	10 + 8	485	410	415	440	470	191	122	100		
TIRRENO 210	207	45 70	211	26	10	10 + 10	515	445	445	475	505	211	122	100		
TIRRENO 230	227	50 70	231	26	11	12 + 10	550	480	480	510	530	231	122	100		

* + 20 cm. con rullo a rete - with net roller - mit Gitterwalze - avec rouleau à grille - con rodillo reticular



- Rullo a spuntoni.
- Spike roller.
- Zinkenwalze.
- Rouleau à pointes.
- Rodillo con puntas.



- Rullo a gabbia.
- Cage roller.
- Stabwalze.
- Rouleau cage.
- Rodillo de barras.



- Rullo a rete.
- Net roller.
- Gitterwalze.
- Rouleau à grille.
- Rodillo reticular.

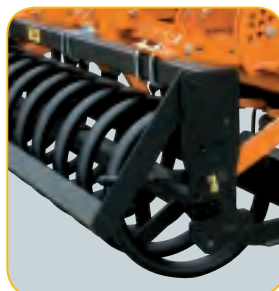

- Rullo a spirale.
- Spiral roller.
- Spiralwalze.
- Rouleau à spire.
- Rodillo de espiral.



- Rullo Packer.
- Packer roller.
- Packerwalze.
- Rouleau packer.
- Rodillo Packer.



- Attacco ai tre punti, cat. I-II.
- 3 point linkage cat. I-II.
- Dreipunktbock, Kat. I-II.
- Attelage à 3 points, Cat. I-II.
- Enganche a los 3 puntos, cat. I-II.



- Riduttore a una velocità PTO 540 g/min - giri rotore: 260.
- Single-speed gearbox, PTO 540: 260 rpm.
- Zapfwelle 540 U/Min., mit 1-Stufe, Rotordrehzahlen: 260 U/Min.
- Boîtier mono vitesse à 540 pdf: 260 T/min.
- Reductor con una velocidad, T.d.f. 540: 260 rpm.



- Seminatrice a spallio per prato.
- Flying seeder machine for lawn.
- Drillmaschine für Wiese.
- Sémoir centrifuge.
- Sembradora centrifuga.

OPTIONALS







- Barra di affinamento con montaggio posteriore o anteriore per rullo a rete e packer.
- Front or rear levelling bar (net and packer roller).
- Vordere oder hintere Krümelschiene (Gitterwalze und Packerwalze).
- Kit lame niveleuse arrière ou avant (Rouleau à grille et rouleau packer).
- Barra niveladora posterior o anterior (Rodillo reticular y rodillo Packer).













- Barra di affinamento posteriore.
- Rear levelling bar.
- Hintere Krümelschiene.
- Kit lame niveleuse arrière.
- Barra niveladora posterior

ADRIATICO

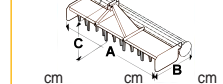

-  Erpice rotante per trattori da 60 a 110 HP. Adatta per la preparazione del terreno per la semina nel campo dell' agricoltura.
-  Herse rotative pour tracteurs entre 60 et 110 CV. Indiqué pour travailler le sol afin de préparer les terrains pour l'ensemencement dans le domaine de l'agriculture.
-  Power harrow for tractors between 60 and 110 HP. Suited to the preparation of seedbeds in farming applications.
-  Grada rotativa para tractores desde 60 hasta 110 CV. Apta para la preparación de la tierra para la siembra en agricultura.
-  Kreiselegge für Schlepper zwischen 60 und 110 PS. Es eignet für die Vorbereitung des Saatbettes in Landwirtschaftsflächen.

Mod.														
	cm	Min	Max	cm	cm	n°	n°	Kg	Kg	Kg	Kg	cm	cm	cm
ADRIATICO 180	178	50	110	183	29	7	8 + 6	620	640	650	725	185	150	122
ADRIATICO 205	201	60	110	206	29	8	8 + 8	670	690	693	780	204	150	122
ADRIATICO 230	225	70	110	230	29	9	10 + 8	720	740	737	845	228	150	122
ADRIATICO 250	248	80	110	253	29	10	10 + 10	765	790	785	905	250	150	122
ADRIATICO 300	295	90	110	300	29	12	12 + 12	860	830	880	960	298	150	122



- Rullo Packer.
- Packer roller.
- Packerwalze.
- Rouleau packer.
- Rodillo Packer.



- Rullo a gabbia.
- Cage roller.
- Stabwalze.
- Rouleau cage.
- Rodillo de barras.



- Rullo a spuntoni.
- Spike roller.
- Zinkenwalze.
- Rouleau à pointes.
- Rodillo con puntas.



- Rullo a spirale.
- Spiral roller.
- Spiralwalze.
- Rouleau à spire.
- Rodillo de espiral.

* Il peso è riferito alla macchina standard (senza accessori) • The weight refers to the machine with standard equipment (without accessories) • Die Gewichtszahl bezieht sich auf die Maschine in Grundausstattung (ohne Sonderausstattung) • Le peso se réfère à la machine standard (sans accessoires) • El peso se refiere al estándar de la máquina (sin accesorios).



- Attacco ai tre punti, cat. II.
- 3 point linkage cat. II.
- Dreipunktbock, Kat. II.
- Attelage à 3 points, Cat. II.
- Enganche a los 3 puntos, cat. II.



- Riduttore a una velocità PTO 540 g/min - giri rotore: 260.
- Single-speed gearbox, PTO 540: 260 rpm.
- Zapfwelle 540 U/Min., mit 1-Stufe, Rotordrehzahlen: 260 U/Min.
- Boîtier mono vitesse à 540 pdf: 260 T/min.
- Reductor con una velocidad, T.d.f. 540: 260 rpm.

OPTIONALS



- Kit 2 rompi traccia
- Eradicators kit (2x)
- Satz Spurlockerer (2x)
- Efface trace (2x)
- Borrahuellas (2x)



- Kit protezione rotori.
- Stones guard, protecting ring.
- Kit Schutzring für Zinkenträger.
- Kit protection rotor.
- Kit de protección de los rotores.

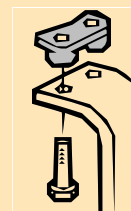
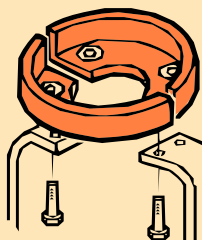

- Kit blocchetti fissaggio denti.
- Blocs-kit for fast clamping of blades.
- Satz Sperrplatten für Zinken (Schnellwechsel).
- Kit brides fixation dents rapid.
- Kit de bridas para sujetar los cuchillas.



- Attacco idraulico per seminatrice.
- Hydraulic 3-point frame (for seeder machine).
- Hydraulisches Anbaugerät für Drillmaschinen.
- Attelage hydraulique pour semoir.
- Enganche hidráulico para sembradora.

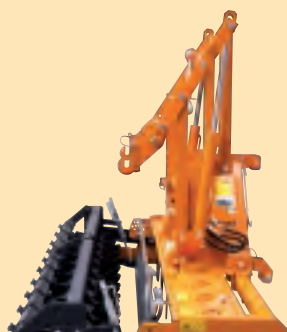



- Barra di affinamento posteriore.
- Rear levelling bar.
- Hintere Krümelschiene.
- Kit lame niveleuse arrière.
- Barra niveladora posterior

ARTICO













 Erpice rotante con cambio di velocità per trattori da 80 a 120 HP. Ideale per la preparazione del terreno per la semina nel campo dell'agricoltura professionale.

 Herse rotative à plusieurs vitesses pour tracteurs entre 80 et 120 CV. Indiqué pour travailler le sol afin de préparer les terrains pour l'ensemencement dans le domaine de l'agriculture professionnelle.

 Multi-speed power harrow for tractors between 80 and 120 HP. Suited to the preparation of soil in professional farming.

 Grada rotativa con cambio de velocidades para tractores desde 80 hasta 120 CV. Apta para la preparación de la tierra para la siembra en agricultura profesional.

 Kreiselegge mit Wechselradgetriebe für Schlepper zwischen 80 und 120 PS. Es eignet für die Bodenvorbereitung in Großflächen.

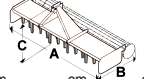
Mod.														
	cm	Min	Max	cm	cm	n°	n°	Kg	Kg	Kg	Kg	cm	cm	cm
ARTICO 250	244	80	120	250	28	10	10 + 10	890	890	930	1040	250	150	122
ARTICO 300	291	90	120	298	28	12	12 + 12	985	990	1025	1150	298	150	122



- Rullo Packer.
- Packer roller.
- Packerwalze.
- Rouleau packer.
- Rodillo Packer.



- Rullo a gabbia.
- Cage roller.
- Stabwalze.
- Rouleau cage.
- Rodillo de barras.



- Rullo a spuntoni.
- Spike roller.
- Zinkenwalze.
- Rouleau à pointes.
- Rodillo con puntas.



- Rullo a spirale.
- Spiral roller.
- Spiralwalze.
- Rouleau à spire.
- Rodillo de espiral.

* Il peso è riferito alla macchina standard (senza accessori) • The weight refers to the machine with standard equipment (without accessories) • Die Gewichtsangabe bezieht sich auf die Maschine in Grundausstattung (ohne Sonderausstattung) • Le poids se réfère à la machine standard (sans accessoires) • El peso se refiere al estándar de la máquina (sin accesorios).



- Attacco ai tre punti, cat. II.
- 3 point linkage cat. II.
- Dreipunktbock, Kat. II.
- Attelage à 3 points, Cat. II.
- Enganche a los 3 puntos, cat. II.



- Cambio di velocità con albero passante PTO 540 g/min
 - giri rotore: 193-236-**288**-353 (PTO 1000 g/min - giri rotore 357).
- Multi-speed gearbox with through shaft PTO 540: 193-236-**288**-353 rpm (PTO 1000: 357 rpm).
- Zapfwellendurchtrieb 540 U/min, Rotordrehzahlen: 193-236-**288**-353 U/min (1000: 357 U/min).
- Boîtier avec double arbre de sortie, changement de vitesses à 540 pdf : 193-236-**288**-353 T/min (Pdf 1000: 357 T/min).
- Cambio de velocidades con eje pasante T.d.f. 540: 193-236-**288**-353 rpm (T.d.f. 1000: 357 rpm).

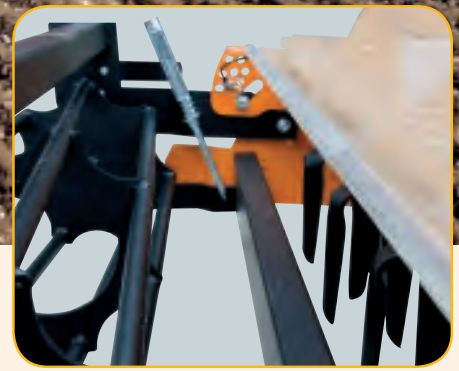

- Barra di affinamento posteriore.
- Rear levelling bar.
- Hintere Krümelschiene.
- Kit lame niveleuse arrière.
- Barra niveladora posterior

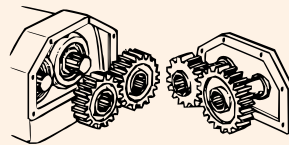

OPTIONALS



- Kit 2 rompi traccia
- Eradicators kit (2x)
- Satz Spurlockerern (2x)
- Efface trace (2x)
- Borrahuellas (2x)



- Kit protezione rotori.
- Stones guard, protecting ring.
- Kit Schutzring für Zinkenträger.
- Kit protection rotor.
- Kit de protección de los rotores.

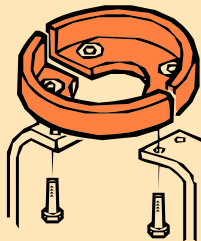

- Kit blocchetti fissaggio denti.
- Blocs-kit for fast clamping of blades.
- Satz Sperrplatten für Zinken (Schnellwechsel).
- Kit brides fixation dents rapid.
- Kit de bridas para sujetar los cuchillas.

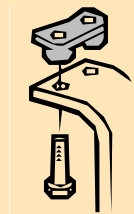

- Attacco idraulico per seminatrice.
- Hydraulic 3-point frame (for seeder machine).
- Hydraulisches Anbaugerät für Drillmaschinen.
- Attelage hydraulique pour semoir.
- Enganche hidráulico para sembradora.

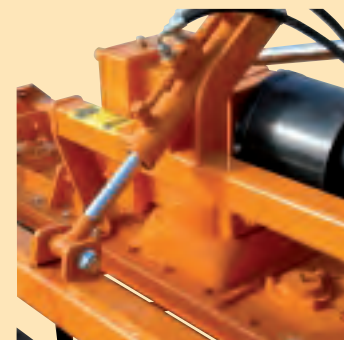
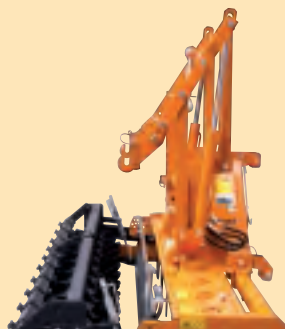

- Regolazione idraulica del rullo.
- Hydraulic adjustment of the roller.
- Hydraulische Verstellung der Walze.
- Réglage hydraulique du rouleau.
- Regulación hidráulica del rodillo.

ANTARTICO



Erpice rotante con cambio di velocità per trattori da 100 a 180 HP. Attrezzatura robusta, ideale per la preparazione del terreno per la semina nel campo dell'agricoltura professionale.



Multi-speed power harrow for tractors between 100 and 180 HP. Heavy-duty implement, suited to the preparation of soil in professional farming.



Kreisellegge mit Wechselradgetriebe für Schlepper zwischen 100 und 180 PS. Verstärktes Gerät für die Bodenvorbereitung in Großflächen,



Herse rotative à plusieurs vitesses pour tracteurs entre 100 et 180 CV. Équipement robuste, indiqué pour travailler le sol afin de préparer les terrains pour l'ensemencement dans le domaine de l'agriculture professionnelle.



Grada rotativa con cambio de velocidades para tractores desde 100 hasta 180 CV. Apta para la preparación de la tierra para la siembra en agricultura profesional.

Mod.														
	cm	Min	Max	cm	cm	n°	n°	Kg	Kg	Kg	Kg	A	B	C
ANTARTICO 300	297	100	180	300	30	12	12 + 12	1310	1350	1360	1480	300	170	137
ANTARTICO 350	350	130	180	354	30	14	14 + 14	1460	1500	1510	1610	354	170	137
ANTARTICO 400	400	150	180	407	30	16	16 + 16	1560	1600	1610	1740	407	170	137



- Rullo Packer.
- Packer roller.
- Packerwalze.
- Rouleau packer.
- Rodillo Packer.



- Rullo a gabbia.
- Cage roller.
- Stabwalze.
- Rouleau cage.
- Rodillo de barras.



- Rullo a spuntoni.
- Spike roller.
- Zinkenwalze.
- Rouleau à pointes.
- Rodillo con puntas.



- Rullo a spirale.
- Spiral roller.
- Spiralwalze.
- Rouleau à spire.
- Rodillo de espiral.

* Il peso è riferito alla macchina standard (senza accessori) • The weight refers to the machine with standard equipment (without accessories) • Die Gewichtszahl bezieht sich auf die Maschine in Grundausstattung (ohne Sonderausstattung) • Le poids se réfère à la machine standard (sans accessoires) • El peso se refiere al estándar de la máquina (sin accesorios).



- Attacco ai tre punti, cat. II-III.
- 3 point linkage cat. II-III.
- Dreipunktbock, Kat. II-III.
- Attelage à 3 points, Cat. II-III.
- Enganche a los 3 puntos, cat. II-III.



- Cambio di velocità con albero passante PTO 1000 g/min – giri rotore: **283-341**.
- Multi-speed gearbox with through shaft PTO 1000: **283-341 rpm**.
- Zapfwellendurchtrieb 1000 U/min, Rotordrehzahlen: **283-341 U/min**.
- Boîtier avec double arbre de sortie, changement de vitesses à 1000 pdf: **283-341 T/min**.
- Cambio de velocidades con eje pasante T.d.f. 1000: **283-341 rpm**.

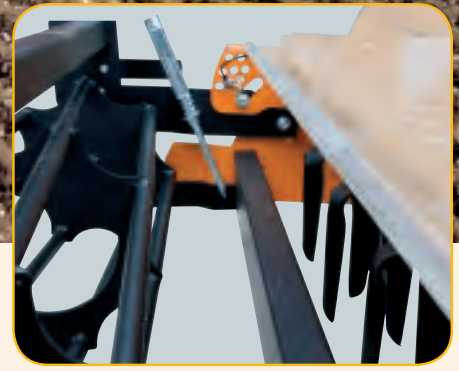

- Barra di affinamento posteriore.
- Rear levelling bar.
- Hintere Krümelschiene.
- Kit lame niveleuse arrière.
- Barra niveladora posterior

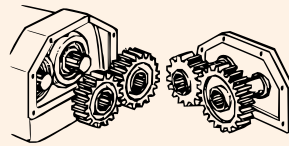

OPTIONALS



- Kit 2 rompi traccia
- Eradicators kit (2x)
- Satz Spurlockerern (2x)
- Efface trace (2x)
- Borrahuellas (2x)



- Kit protezione rotori.
- Stones guard, protecting ring.
- Kit Schutzring für Zinkenträger.
- Kit protection rotor.
- Kit de protección de los rotores.

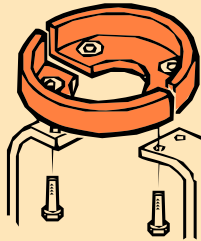

- Kit blocchetti fissaggio denti.
- Blocs-kit for fast clamping of blades.
- Satz Sperrplatten für Zinken (Schnellwechsel).
- Kit brides fixation dents rapid.
- Kit de bridas para sujetar los cuchillas.

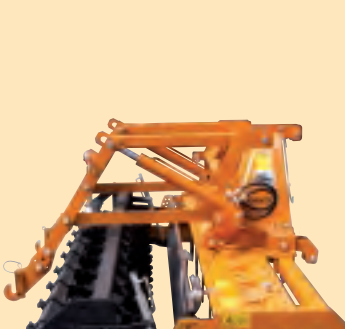
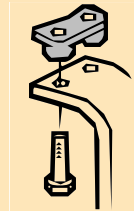

- Attacco idraulico per seminatrice.
- Hydraulic 3-point frame (for seeder machine).
- Hydraulisches Anbaugerät für Drillmaschinen.
- Attelage hydraulique pour semoir.
- Enganche hidráulico para sembradora.

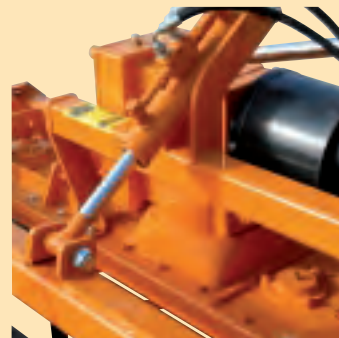

- Regolazione idraulica del rullo.
- Hydraulic adjustment of the roller.
- Hydraulische Verstellung der Walze.
- Réglage hydraulique du rouleau.
- Regulación hidráulica del rodillo.

INDIANO



Erpice pieghevole per trattori da 80 a 150 HP. Adatto per la preparazione e il miglioramento del terreno per la semina nel campo dell'agricoltura professionale, a ingombro ridotto per il trasporto su strada.



Herse rotative repliable pour tracteurs entre 80 et 150 CV. Indiqué pour travailler le sol afin de préparer et améliorer les terrains pour l'ensemencement dans le domaine de l'agriculture professionnelle, dimensions réduites pour le transport sur route.



Power harrow with folding system, for tractors from 80 up to 150 HP. Suited to preparation of soil in professional farming.



Grada rotativa plegable para tractores desde 80 hasta 150 CV. Apta para la preparación de la tierra para la siembra en agricultura profesional.



Zusammenklappbar Kreiselege für Schlepper zwischen 80 und 150 PS. Es eignet sich für die Bodenvorbereitung in Großflächen.

Mod.															
	cm	Min	Max	cm	cm	n°	n°	Kg	Kg	Kg	Kg	cm	cm	cm	
INDIANO 300	300	80	150	200	28	12	12 + 12	1315	1335	1405	1480	308	160	120	
INDIANO 360	360	100	150	200	28	14	14 + 14	1480	1500	1585	1685	355	160	120	
INDIANO 400	400	130	150	200	28	16	16 + 16	1645	1675	1760	1890	402	160	120	



- Rullo Packer.
- Packer roller.
- Packerwalze.
- Rouleau packer.
- Rodillo Packer.



- Rullo a gabbia.
- Cage roller.
- Stabwalze.
- Rouleau cage.
- Rodillo de barras.



- Rullo a spuntoni.
- Spike roller.
- Zinkenwalze.
- Rouleau à pointes.
- Rodillo con puntas.



- Rullo a spirale.
- Spiral roller.
- Spiralwalze.
- Rouleau à spire.
- Rodillo de espiral.

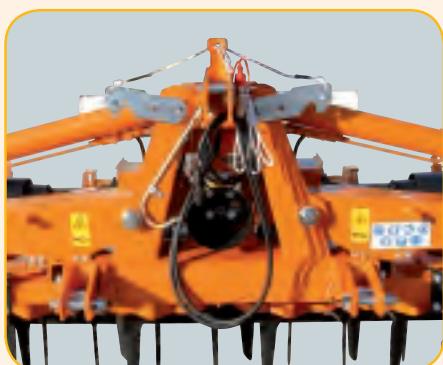

- Attacco ai tre punti, cat. II.
- 3 point linkage cat. II.
- Dreipunktbock, Kat. II.
- Attelage à 3 points, Cat. II.
- Enganche a los 3 puntos, cat. II.

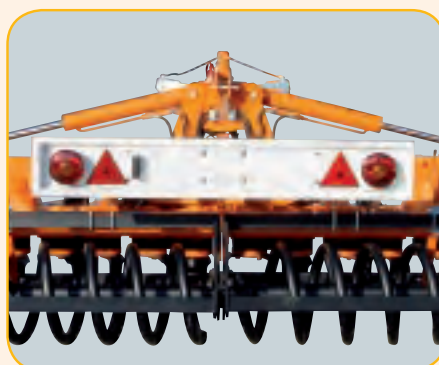

- Barra fanali per il trasporto.
- Rear lights equipment.
- Heckbeleuchtung.
- Kit éclairage.
- Barra con luces para el transporte.



- Riduttore centrale PTO 1000 g/min e due riduttori laterali - giri rotore: 357.
- Central gearbox PTO 1000 rpm and 2 side reduction gears: 357 rpm.
- Zentral Getriebe 1000 U/Min. mit 2 Seitengetriebe, Rotordrehzahlen: 357 U/Min.
- Boîtier central à 1000 pdf et deux boîtiers latéraux : 357 T/min.
- Reductor central T.d.f.1000 rpm y 2 reductores laterales: 357 rpm.



- Kit 2 rompi traccia
- Eradicators kit (2x)
- Satz Spurlockerern (2x)
- Efface trace (2x)
- Borrahuellas (2x)

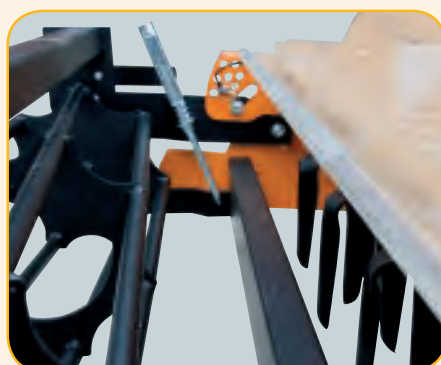

- Barra di affinamento posteriore.
- Rear levelling bar.
- Hintere Krümelschiene.
- Kit lame niveleuse arrière.
- Barra niveladora posterior

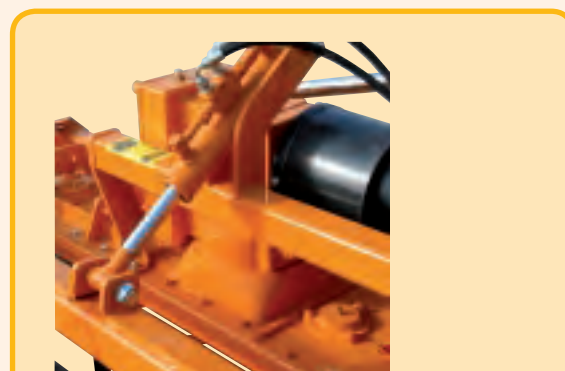

- Regolazione idraulica del rullo.
- Hydraulic adjustment of the roller.
- Hydraulische Verstellung der Walze.
- Réglage hydraulique du rouleau.
- Regulación hidráulica del rodillo.

OPTIONALS

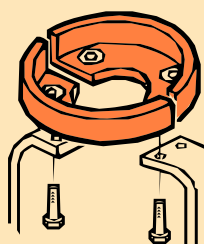

- Kit protezione rotori.
- Stones guard, protecting ring.
- Kit Schutzring für Zinkenträger.
- Kit protection rotor.
- Kit de protección de los rotores.

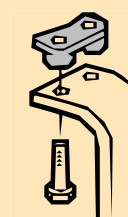



- Kit blocchetti fissaggio denti.
- Blocs-kit for fast clamping of blades.
- Satz Sperrplatten für Zinken (Schnellwechsel).
- Kit brides fixation dents rapid.
- Kit de bridas para sujetar los cuchillas.

ATLANTICO













 Erpice pieghevole con cambio di velocità per trattori da 120 a 230 HP. Adatto per la preparazione e il miglioramento del terreno per la semina nel campo dell'agricoltura professionale, a ingombro ridotto per il trasporto su strada.

 Herse rotative repliable à plusieurs vitesses pour tracteurs entre 120 et 230 CV. Indiqué pour travailler le sol afin de préparer et améliorer les terrains pour l'ensemencement dans le domaine de l'agriculture professionnelle, dimensions réduites pour le transport sur route.

 Power harrow with folding system and multi-speed gearbox, for tractors from 120 up to 230 HP. Suited to preparation of soil in professional farming.

 Grada rotativa plegable con cambio de velocidad para tractores desde 120 hasta 230 CV. Apta para la preparación de la tierra para la siembra en agricultura profesional.

 Zusammenklappbar Kreiselegge mit Wechselradgetriebe, für Schlepper zwischen 120 und 230 PS. Es eignet sich für die Bodenvorbereitung in Großflächen.

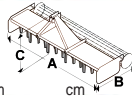
Mod.		 HP												
	cm	Min	Max	cm	cm	n°	n°	Kg	Kg	Kg	Kg	cm	cm	cm
ATLANTICO 400	400	120	230	240	28	16	16 + 16	1990	2075	2095	2210	A	B	C
ATLANTICO 500	500	150	230	240	28	20	20 + 20	2170	2230	2250	2475	402	160	130
												495	160	130

* Il peso è riferito alla macchina standard (senza accessori) • The weight refers to the machine with standard equipment (without accessories) • Die Gewichtszahl bezieht sich auf die Maschine in Grundausstattung (ohne Sonderausstattung) • Le poids se réfère à la machine standard (sans accessoires) • El peso se refiere al estándar de la máquina (sin accesorios).



- Rullo Packer.
- Packer roller.
- Packerwalze.
- Rouleau packer.
- Rodillo Packer.



- Rullo a gabbia.
- Cage roller.
- Stabwalze.
- Rouleau cage.
- Rodillo de barras.



- Rullo a spuntoni.
- Spike roller.
- Zinkenwalze.
- Rouleau à pointes.
- Rodillo con puntas.



- Rullo a spirale.
- Spiral roller.
- Spiralwalze.
- Rouleau à spire.
- Rodillo de espiral.



- Attacco ai tre punti, cat. II-III.
- 3 point linkage cat. II-III.
- Dreipunktbock, Kat. II-III.
- Attelage à 3 points, Cat. II-III.
- Enganche a los 3 puntos, cat. II-III.

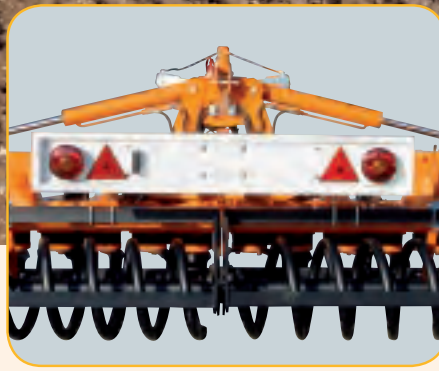

- Barra fanali per il trasporto.
- Rear lights equipment.
- Heckbeleuchtung.
- Kit éclairage.
- Barra con luces para el transporte.

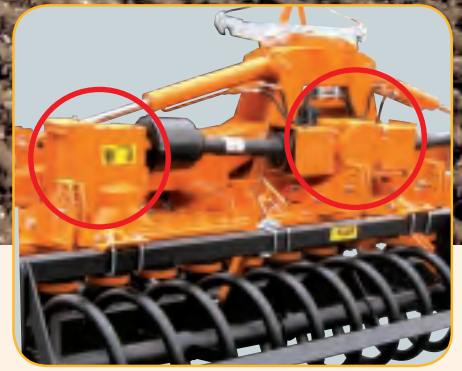

- Riduttore centrale PTO 1000 g/min e 2 cambi laterali di velocità - giri rotori: 232-285-348-427.
- Central gearbox, PTO 1000 rpm and side multi-speed gearboxes: 232-285-348-427 rpm.
- Zentral Getriebe 1000 U/Min., mit 2 Seitengetriebe, Rotordrehzahlen: 232-285-348-427 U/min.
- Boîtier central à 1000 pdf et deux boîtiers latéraux avec changement de vitesses: 232-285-348-427 T/min.
- Reductor central T.d.f.1000 rpm y 2 cambios laterales de velocidades: 232-285-348-427 rpm.



- Sistema flottante.
- Floating system.
- Schwimmstellung-System.
- Système flottant.
- Sistema flotante.

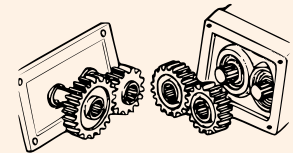
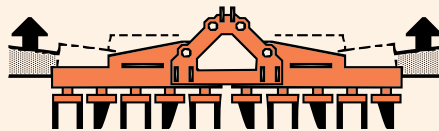

- Kit 2 rompi traccia
- Eradicators kit (2x)
- Satz Spurlockeren (2x)
- Efface trace (2x)
- Borrahuellas (2x)



- Barra di affinamento posteriore, applicata sul rullo.
- Rear levelling bar, mounted on roller.
- Hintere Krümelschiene, auf Walze montiert.
- Kit lame niveleuse arrière, montée sur rouleau.
- Barra niveladora posterior, montada en rodillo.



- Regolazione idraulica del rullo.
- Hydraulic adjustment of the roller.
- Hydraulische Verstellung der Walze.
- Réglage hydraulique du rouleau.
- Regulación hidráulica del rodillo.

OPTIONALS

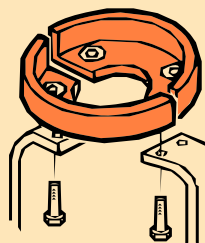

- Kit protezione rotori.
- Stones guard, protecting ring.
- Kit Schutzring für Zinkenträger.
- Kit protection rotor.
- Kit de protección de los rotores.

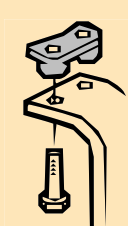



- Kit blocchetti fissaggio denti.
- Blocs-kit for fast clamping of blades.
- Satz Sperrplatten für Zinken (Schnellwechsel).
- Kit brides fixation dents rapid.
- Kit de bridas para sujetar los cuchillas.

PACIFICO













 Erpice pieghevole con cambio di velocità per trattori da 120 a 230 HP. Adatto per la preparazione e il miglioramento del terreno per la semina nel campo dell'agricoltura professionale, a ingombro ridotto per il trasporto su strada.

 Herse rotative repliable à plusieurs vitesses pour tracteurs entre 120 et 230 CV. Indiqué pour travailler le sol afin de préparer et améliorer les terrains pour l'ensemencement dans le domaine de l'agriculture professionnelle, dimensions réduites pour le transport sur route.

 Power harrow with folding system and multi-speed gearbox, for tractors from 120 up to 230 HP. Suited to preparation of soil in professional farming.

 Grada rotativa plegable con cambio de velocidad para tractores desde 120 hasta 230 CV. Apta para la preparación de la tierra para la siembra en agricultura profesional.

 Zusammenklappbar Kreiselege mit Wechselradgetriebe, für Schlepper zwischen 120 und 230 PS. Es eignet sich für die Bodenvorbereitung in Großflächen.

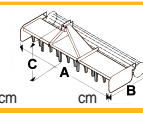
Mod.														
	cm	Min	Max	cm	cm	n°	n°	Kg	Kg	Kg	Kg	A	B	C
PACIFICO 500	497	150	300	245	31	20	20 + 20	2820	2870	2890	3080	505	160	130
PACIFICO 600	597	180	300	245	31	24	24 + 24	3000	3080	3100	3340	605	160	130



- Rullo Packer.
- Packer roller.
- Packerwalze.
- Rouleau packer.
- Rodillo Packer.



- Rullo a gabbia.
- Cage roller.
- Stabwalze.
- Rouleau cage.
- Rodillo de barras.



- Rullo a spuntoni.
- Spike roller.
- Zinkenwalze.
- Rouleau à pointes.
- Rodillo con puntas.



- Rullo a spirale.
- Spiral roller.
- Spiralwalze.
- Rouleau à spire.
- Rodillo de espiral.

* Il peso è riferito alla macchina standard (senza accessori) • The weight refers to the machine with standard equipment (without accessories) • Die Gewichtszahl bezieht sich auf die Maschine in Grundausstattung (ohne Sonderausstattung) • Le poids se réfère à la machine standard (sans accessoires) • El peso se refiere al estándar de la máquina (sin accesorios).



- Attacco ai tre punti, cat. II-III.
- 3 point linkage cat. II-III.
- Dreipunktbock, Kat. II-III.
- Attelage à 3 points, Cat. II-III.
- Enganche a los 3 puntos, cat. II-III.

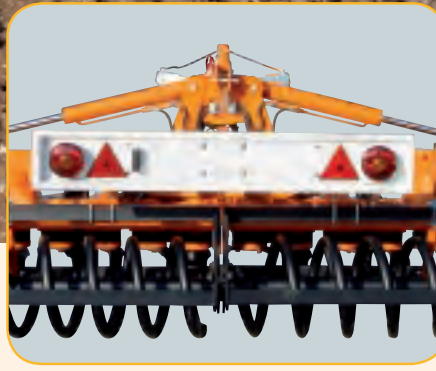

- Barra fanali per il trasporto.
- Rear lights equipment.
- Heckbeleuchtung.
- Kit éclairage.
- Barra con luces para el transporte.



- Riduttore centrale PTO 1000 g/min e 2 cambi laterali di velocità con albero passante - giri rotor: **283-341**.
- Central gearbox, PTO 1000 rpm and side multi-speed gearboxes with through shaft: **283-341 rpm**.
- Zentral Getriebe 1000 U/Min., mit Zapfwelldurchtrieb, Rotordrehzahlen: **283-341 U/min.**
- Boîtier central à 1000 pdf et deux boîtiers latéraux avec double arbre de sortie avec changement de vitesses: **283-341 T/min.**
- Reductor central T.d.f.1000 rpm y 2 cambios laterales de velocidades con eje pasante: **283-341 rpm.**

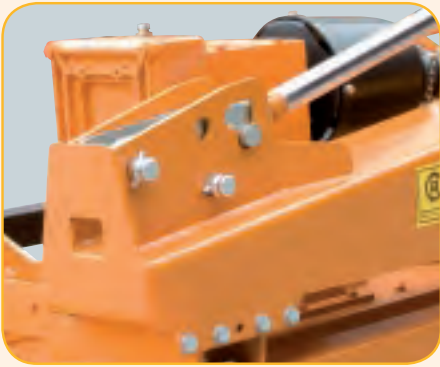

- Sistema flottante.
- Floating system.
- Schwimmstellung-System.
- Système flottant.
- Sistema flotante.

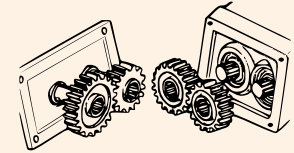
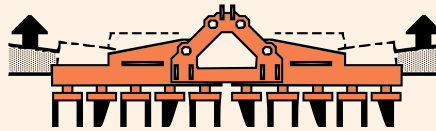

- Kit 2 rompi traccia
- Eradicators kit (2x)
- Satz Spurlockeren (2x)
- Efface trace (2x)
- Borrahuellas (2x)



- Barra di affinamento posteriore, applicata sul rullo.
- Rear levelling bar, mounted on roller.
- Hintere Krümelschiene, auf Walze montiert.
- Kit lame niveleuse arrière, montée sur rouleau.
- Barra niveladora posterior, montada en rodillo.

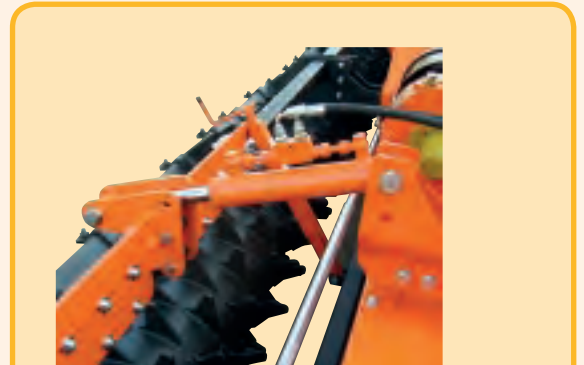

- Regolazione idraulica del rullo.
- Hydraulic adjustment of the roller.
- Hydraulische Verstellung der Walze.
- Réglage hydraulique du rouleau.
- Regulación hidráulica del rodillo.

OPTIONALS

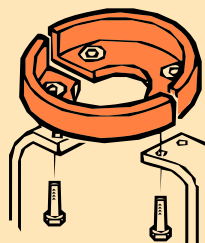

- Kit protezione rotori.
- Stones guard, protecting ring.
- Kit Schutzring für Zinkenträger.
- Kit protection rotor.
- Kit de protección de los rotores.

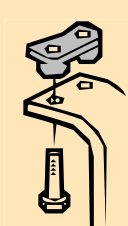

- Kit blocchetti fissaggio denti.
- Blocs-kit for fast clamping of blades.
- Satz Sperrplatten für Zinken (Schnellwechsel).
- Kit brides fixation dents rapid.
- Kit de bridas para sujetar los cuchillas.

STANDARD

SCHEMA DI TRASMISSIONE / LAYOUTS OF ROTORS ASSEMBLY

SCHNITTBILD GETRIEBEWANNE / SCHEMA TRANSMISSIONS / ESQUEMA DE TRANSMISIÓN

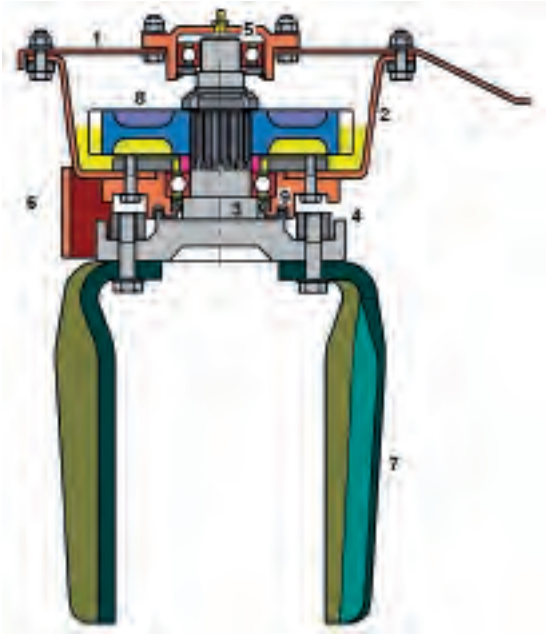

MOD. IONIO - TIRRENO

1. **Coperchio vasca spessore 4 mm** - Outer body/cover (th. 4mm.) - Getriebewanne Oben mit einer Stärke von 4 mm - Couvercle caisse avec 4 mm. d'épaisseur - Grosor del chasis exterior de 4 mm.
2. **Vasca spessore 3 mm** - Inferior body (pool), th. 3 mm. - Getriebewanne mit einer Stärke von 3 mm - Caisse avec 3 mm. d'épaisseur - Grosor del chasis inferior de 3 mm.
3. **Portadenti e albero in acciaio forgiati in un unico pezzo** - Blades carrier steel-made shaft in one piece forged - Zinkenträger und Antriebswelle Stahlgebanten aus einem Stück geschmiedet - Porte-couteaux et arbre en acier et trempés d'un seul bloc - Porta cuchillas y eje en acero y forjados de una sola pieza.
4. **Viti fissaggio denti** - Fixing nut for blades - Mutter für Zinken-Befestigung - Brides de fixation couteaux- Tuerca de fijación para los cuchillas.
5. **Cuscinetto superiore ingrassato a vita** - Top bearing (lubricated for life) - Oben-Lager (Lebenlang geschmiert) - Roulement supérieur graissé à vie- cojinete superior engrasado de por vida.
6. **Protezione anteriore contro le pietre** - Front protection against stones - Frontschutz gegen Steinen - Protection frontale pierres - Protección frontal contra las piedras.
7. **Denti in acciaio al boro temprato** - Hardened boron steel blades - Zinken aus gehartetem Borstahl - Couteaux en acier bore tempéré- Cuchillas de acero al boro templado.
8. **Ingranaggio in acciaio trattato** - Hardened gear, in lubricant bath - Zahnräder aus vergütetem Stahl, in Ölbad - Engrenage en acier traité à bain dans lubrifiant- Engranajes endurecidos en baño de aceite.
9. **Tenuta con paraolio più labirinto** - Seal ring and labyrinth - Simmering und Labyrinth - Bague d'étanchéité plus joyspir - Estanqueidad con retén contra pérdida de aceite y una junta laberíntica.

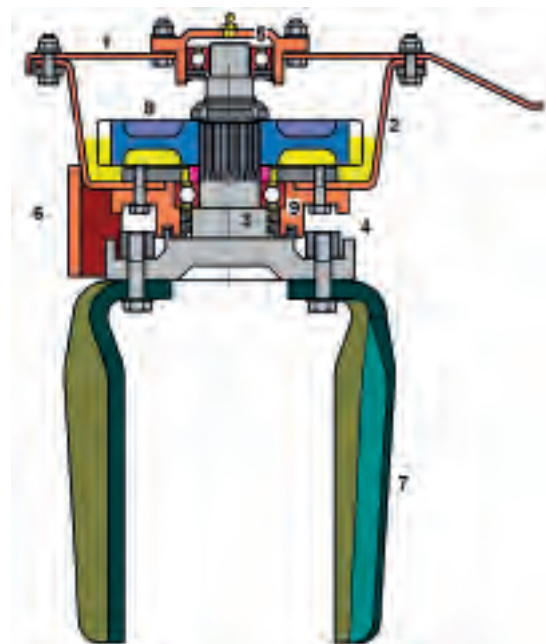

MOD. ADRIATICO - ARTICO - INDIANO - ATLANTICO

1. **Coperchio vasca spessore 4 mm** - Outer body/cover (th. 4mm.) - Getriebewanne Oben mit einer Stärke von 4 mm - Couvercle caisse avec 4 mm. d'épaisseur - Grosor del chasis exterior de 4 mm.
2. **Vasca spessore 4 mm** - Inferior body (pool), th. 4 mm. - Getriebewanne mit einer Stärke von 4 mm - Caisse avec 4 mm. d'épaisseur - Grosor del chasis inferior de 4 mm.
3. **Portadenti e albero in acciaio forgiato in un unico pezzo** - Blades carrier steel-made shaft in one piece forged - Zinkenträger und Antriebswelle Stahlgebanten aus einem Stück geschmiedet - Porte-couteaux et arbre en acier trempé d'un seul bloc - Porta cuchillas y eje en acero forjado de una sola pieza.
4. **Viti fissaggio denti** - Fixing nut for blades - Mutter für Zinken-Befestigung - Brides de fixation couteaux- Tuerca de fijación para los cuchillas.
5. **Cuscinetto superiore ingrassato a vita** - Top bearing (lubricated for life) - Oben-Lager (Lebenlang geschmiert) - Roulement supérieur graissé à vie- Cojinete superior engrasado de por vida.
6. **Protezione anteriore contro le pietre** - Front protection against stones - Frontschutz gegen Steinen - Protection frontale pierres - Protección frontal contra las piedras.
7. **Denti in acciaio al boro temprato** - Hardened boron steel blades - Zinken aus gehartetem Borstahl - Couteaux en acier bore tempéré- Cuchillas de acero al boro templado.
8. **Ingranaggio in acciaio trattato** - Hardened gear, in lubricant bath - Zahnräder aus vergütetem Stahl, in Ölbad - Engrenage en acier traité à bain dans lubrifiant- Engranajes endurecidos en baño de aceite.
9. **Doppia tenuta con paraolio più labirinto** - Double seal ring and labyrinth - Doppelte Simmering und Labyrinth - Double bague d'étanchéité plus joyspir - Doble estanqueidad con retén contra pérdida de aceite y una junta laberíntica.

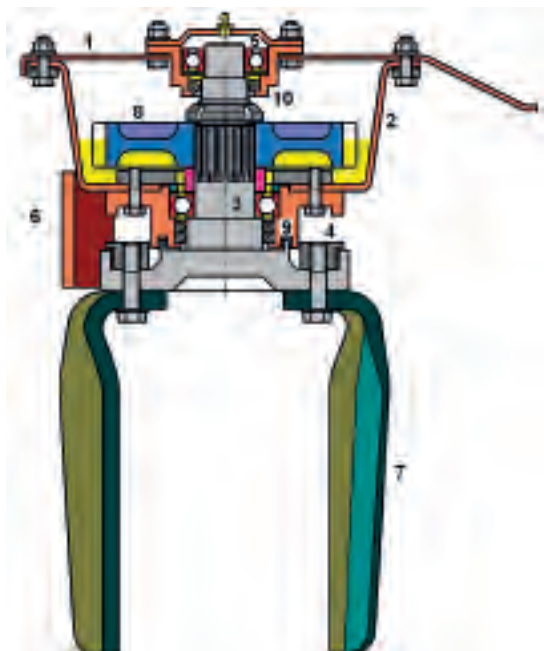

MOD. ANTARTICO - PACIFICO

1. **Coperchio vasca spessore 6 mm** - Outer body/cover (th. 6mm.) -
Getriebewanne Oben mit einer Stärke von 6 mm - Couvercle caisse avec
6 mm. d'épaisseur- Grosor del chasis exterior de 6 mm.
2. **Vasca spessore 6 mm** - Inferior body (pool), th. 6 mm.
- Getriebewanne mit einer Stärke von 6 mm - Caisse avec 6 mm.
d'épaisseur- Grosor del chasis inferior de 6 mm.
3. **Portadenti e albero in acciaio forgiato in un unico pezzo**
- Blades carrier steel-made shaft in one piece forged - Zinkenträger und
Antriebswelle Stahlgebanten aus einem Stück geschmiedet - Porte-
couteaux et arbre en acier trempé d'un seul bloc - Porta cuchillas y eje en
acero forjado de una sola pieza.
4. **Viti fissaggio denti** - Fixing nut for blades - Mutter für Zinken-Befestigung
- Brides de fixation couteaux- Tuerca de fijación para los cuchillas.
5. **Cuscinetto superiore ingrassato a vita** - Top bearing (lubricated for life)
- Oben-Lager (Lebenlang geschmiert) - Roulement supérieur graissé à
vie- Cojinete superior engrasado de por vida.
6. **Protezione anteriore contro le pietre** - Front protection against stones -
Frontschutz gegen Stainen - Protection frontale pierres
- Protección frontal contra las piedras.
7. **Denti in acciaio al boro temprato** - Hardened boron steel blades
- Zinken aus gehartetem Borstahl - Couteaux en acier bore tempéré-
Cuchillas de acero al boro templado.
8. **Ingranaggio in acciaio trattato** - Hardened gear, in lubricant bath -
Zahnräder aus vergütetem Stahl, in Ölbad - Engrenage en acier traité à
bain dans lubrifiant- Engranajes endurecidos en baño de aceite.
9. **Doppia tenuta con paraolio più labirinto** - Double seal ring and labyrinth
- Doppelte Simmerring und Labyrinth - Double bague d'étanchéité plus
joyspir - Doble estanqueidad con retén contra pérdida de aceite y una
junta laberíntica.
10. **Anello tenuta per cuscinetto superiore** - Seal ring for top bearing -
Simmerring für oben-Lager - Bague d'étanchéité pour roulement supérieur
- Retén para cojinete superior.



- Denti in acciaio al boro temprato (destro/sinistro).
- Hardened boron steel blades (right/left).
- Zinken aus gehartetem Borstahl (rechts / links).
- Couteaux en acier au bore trempé (droite/gauche).
- Cuchillas de acero al boro templado (derecha/izquierda).



- Portadenti e albero in acciaio forgiati in un unico pezzo.
- Blades carrier steel-made shaft in one piece forged.
- Zinkenträger und Antriebswelle Stahlgebanten aus einem Stück geschmiedet.
- Porte-couteaux et arbre en acier et trempés d'un seul bloc.
- Porta cuchillas y eje en acero y forjados de una sola pieza.



STANDARD

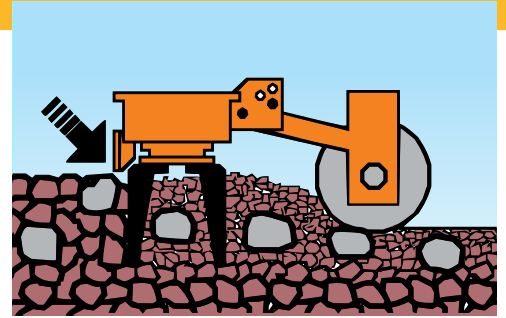
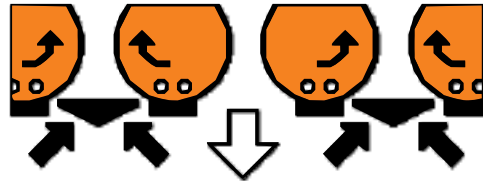

IONIO	TIRRENO	ADRIATICO	ARTICO	ANTARTICO	INDIANO	ATLANTICO	PACIFICO
<input checked="" type="checkbox"/>	<input checked="" type="checkbox"/>	<input checked="" type="checkbox"/>	<input checked="" type="checkbox"/>	<input checked="" type="checkbox"/>	<input checked="" type="checkbox"/>	<input checked="" type="checkbox"/>	<input checked="" type="checkbox"/>

Protezione parasassi - Protections between rotors, against stones - Keilförmige Platte zwischen die Zinkenträgern
 Protections pierres - Protección entre los rotores, contra piedras

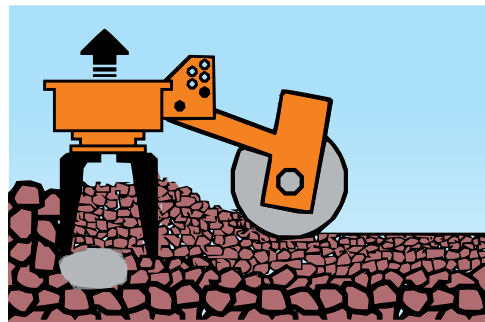
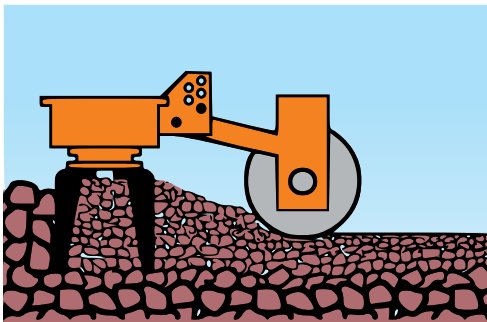

IONIO	TIRRENO	ADRIATICO	ARTICO	ANTARTICO	INDIANO	ATLANTICO	PACIFICO
<input checked="" type="checkbox"/>	<input checked="" type="checkbox"/>	<input checked="" type="checkbox"/>	<input checked="" type="checkbox"/>	<input checked="" type="checkbox"/>	<input checked="" type="checkbox"/>	<input checked="" type="checkbox"/>	<input checked="" type="checkbox"/>

Rullo flottante a regolazione rapida - Quick device for roller height adjustment - Schnellverstellung der Walze
 Réglage rapide du rouleau - Rodillo flotante con regulación rápida

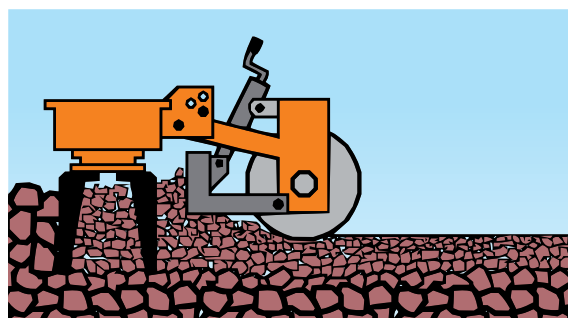

IONIO	TIRRENO	ADRIATICO	ARTICO	ANTARTICO	INDIANO	ATLANTICO	PACIFICO
-	OPTIONAL*	OPTIONAL	<input checked="" type="checkbox"/>	<input checked="" type="checkbox"/>	<input checked="" type="checkbox"/>	<input checked="" type="checkbox"/>	<input checked="" type="checkbox"/>

Barra di affinamento, applicata sul rullo - Levelling bar, mounted on roller - Krümelschiene auf Walze montiert
 Kit lame niveleuse, montée sur rouleau - Barra niveladora, montada en rodillo

* solo su rullo a gabbia, spuntoni e spirale - only for spike, spiral and cage roller - nur für Zinkenwalze, Spiralwalze und Stabwalze
 seulement pour rouleau à pointes, à spire et cage - solo para rodillo con puntas, de espiral y e de barras

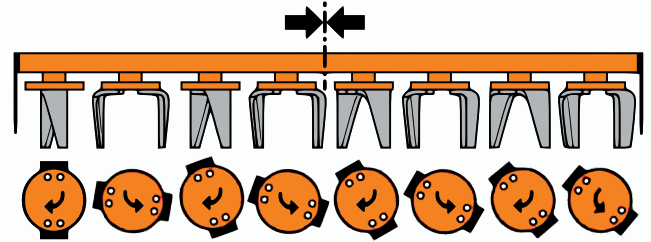
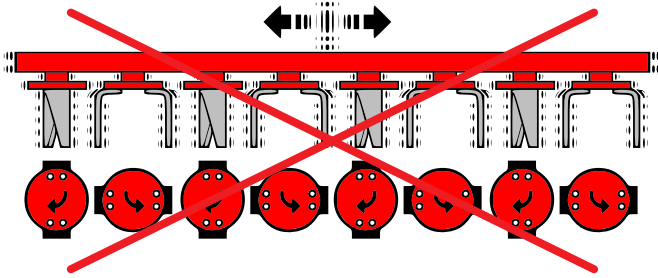

IONIO	TIRRENO	ADRIATICO	ARTICO	ANTARTICO	INDIANO	ATLANTICO	PACIFICO
✓	✓	✓	✓	✓	✓	✓	✓

Rotori portadenti senza vibrazioni - Blades carrier, without vibrations - Zinkenträger ohne Vibrationen - Rotor porte couteaux sans vibrations
 Rotores porta cuchillas sin vibraciones

(A)

Fiancata mobile.
Flexible side of body.
Bewegliche Seitebleche.
Côté latérale mobile.
Perfil lateral móvil.



(B)

Fiancata regolabile in altezza.
Height adjustable side of body.
Einstellbare Seitebleche.
Côté latérale réglable en hauteur.
Perfil regulable en altura.



	IONIO	TIRRENO	ADRIATICO	ARTICO	ANTARTICO	INDIANO	ATLANTICO	PACIFICO
A	-	✓	✓	✓	✓	✓	✓	✓
B	✓	✓	✓	✓	✓	✓	✓	✓

CARDANO CON LIMITATORE DI SICUREZZA A BULLONE
PTO drive Shaft with shear bolt.
Gelenkwelle mit Scherbolzen.
Cardan limiteur à sécurité boulon .
Eje cardán con perno de seguridad.

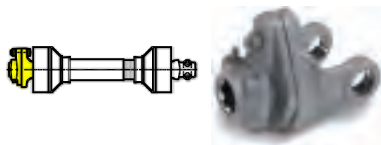

CARDANO CON LIMITATORE DI SICUREZZA A CAMME
PTO drive Shaft with cam clutch.
Gelenkwelle mit Nockenschaltkupplung.
Cardan à cames.
Eje cardán con levas.

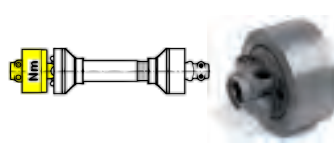

CARDANO CON LIMITATORE DI SICUREZZA A FRIZIONE
PTO drive Shaft with slip clutch.
Gelenkwelle mit Rutschkupplung.
Cardan avec limiteur à sécurité avec friction.
Eje cardan con fricción.

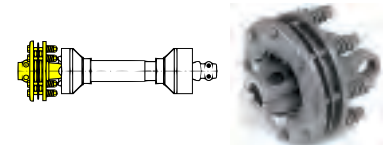

IONIO	✓							
TIRRENO	✓						OPTIONAL	
ADRIATICO	✓						OPTIONAL	
ARTICO	✓						OPTIONAL	
ANTARTICO	✓				OPTIONAL			
INDIANO	✓ *				OPTIONAL			
ATLANTICO	✓ *				OPTIONAL			
PACIFICO	✓ *				OPTIONAL			

* sui cardani laterali - on side PTO drive shafts - sur le cardanes laterales - auf den seitliche Gelenkwellen - sobre ejes cardanes laterales

RULLI

ROLLERS / WALZEN / ROULEAUX / RODILLOS

La regolazione in altezza determina la profondità di lavoro della macchina, la regolazione viene effettuata mediante dei perni oppure con martinetti idraulici. - *The height adjusting gives the depth of work.*

The adjusting is done by means of mechanical pins (standard) or of hydraulic rams (optional). - Die Arbeitstiefe der Maschine wird über die Höheneinstellung der Walze eingestellt. Diese erfolgt entweder

Il **rullo a spuntoni** è consigliato su terreni umidi, argillosi ed in condizioni difficili, non compatta il terreno e lo lascia arieggiato e livellato, si utilizza prevalentemente su terreni arati in profondità.

Spike roller: The Spike roller is recommended on humid soils, clay soils and alike. It does not compact the soil and leaves it ventilated and leveled. Mostly used on deep ploughed soils.

Zinkenwalze: Die Zinkenwalze wird für den Einsatz auf lehmigen, feuchten Böden und bei schwierigen Bedingungen empfohlen. Durch den Einsatz der Zinkenwalze wird der Boden nicht verfestigt und gleichmäßig eingeebnet. Die Zinkenwalze wird vorwiegend auf gepflügten Böden eingesetzt.

Rouleau à pointes: Le rouleau à pointes est conseillé sur les terrains ayant beaucoup d'humidité, argile, et/ou en conditions difficiles. Il ne compacte pas le sol, il le laisse respirer et pour en étant nivelé. Le choix de ce rouleau est principalement dans des terrains à culture de riz et labourés en profondeur.

Rodillo con puntas: el Rodillo con puntas se recomienda para suelos húmedos y homogéneos. No compacta el suelo, dejándolo ventilado y nivelado. Generalmente se utiliza para un arado profundo del suelo.

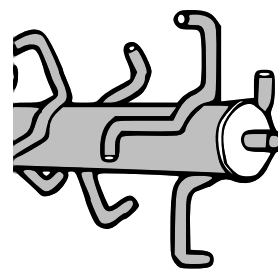

Il **rullo a gabbia** è consigliato su terreni medi e con scarsa umidità. Garantisce un'ottimale preparazione del letto di semina.

Cage roller: The Cage roller is recommended on mid-soft soils and with poor humidity. It guarantees an ideal preparation for seedbeds.

Stabwalze: Die Stabwalze wird für den Einsatz auf mittleren Böden mit geringer Feuchte empfohlen. Die Stabwalze garantiert eine optimale Saatbettbereitung.

Rouleau cage: Le rouleau cage est conseillé sur tous terrains moyens et à faible humidité. Ce rouleau assure une préparation optimale du lit de semence.

Rodillo de barras: el rodillo de barras se recomienda para suelos semi-blandos y poco húmedos. Garantiza una preparación ideal de la cama de sementera.

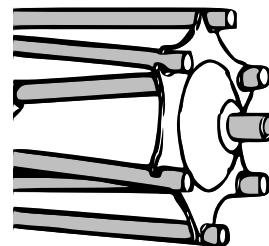

Il **rullo packer** viene utilizzato per sminuzzare ulteriormente le zolle superficiali e per garantire un compattamento ottimale del terreno per la semina. Consigliato per utilizzo con la presenza della seminatrice.

Packer roller: The Packer roller makes a fine crumbling of the superficial sods and an ideal compacting of soil for the preparation of seedbeds. Recommended in combination with seeders machines.

Packerwalze: Die Packerwalze wird verwendet, um Kluten auf der Oberfläche weiter zu zerkleinern. Darüber hinaus garantiert die Packerwalze einen optimalen Bodenschluss für die Saat.

Die Packerwalze wird auch in Kombination mit einer Drillmaschine empfohlen.

Rouleau packer: Le rouleau packer est utilisé pour mieux briser le sol et pour obtenir un compactage optimal du même. Il est fortement recommandé en utilisation combiné avec semoir.

Rodillo packer: el rodillo packer realiza un fino desmoronamiento de los terrones superficiales del suelo y una compactación ideal para la preparación de la cama de sementera.

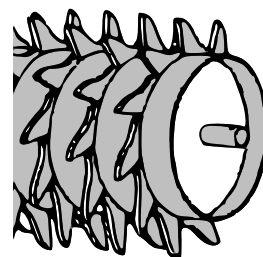

über Bolzen (im Serien) oder mittels hydraulischen Winden (Option).
 - *Le réglage en hauteur permet d'obtenir la profondeur de travail de la machine, le réglage est effectué par des pivots ou par des vérins*

hydrauliques. - El ajuste de la altura proporciona la profundidad de trabajo. El ajuste se realiza por medio de terminales mecánicas (estándar) o de cilindros hidráulicos (opcional).

Il **rullo a spirale** è consigliato su terreni leggeri e sabbiosi.

Spiral roller: The Spiral roller is recommended on soft and sandy soils.

Spiralwalze: Die Spiralwalze wird für den Einsatz auf leichten, sandigen Böden empfohlen.

Rouleau spire: Ce rouleau est conseillé sur les terrains légers et sableux.

Rodillo de espiral: el rodillo de espiral se recomienda en suelos blandos y arenosos.

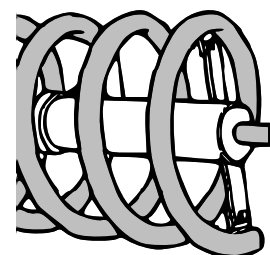

Il **rullo a rete** viene utilizzato per sminuzzare ulteriormente le zolle superficiali e non compatta eccessivamente il terreno e lo lascia livellato. Consigliato per utilizzo con la presenza della seminatrice.

Net roller: The Net roller makes a fine crumbling of the superficial sods and an ideal compacting of soil for the preparation of seedbeds. Recommended in combination with seeders machines.

Netzwalze: Die Gitterwalze wird verwendet, um Kluten auf der Oberfläche weiter zu zerkleinern. Durch den Einsatz der Gitterwalze wird der Boden nicht übermäßig verfestigt und

gleichmäßig eingeebnet. Die Gitterwalze wird auch in Kombination mit einer Drillmaschine empfohlen.

Rouleau à grille: Ce rouleau est conseillé pour briser ultérieurement les mottes, par contre il ne compacte trop le terrain nonobstant qu'il le laisse nivelé. Il est conseillé pour utilisation en présence de semoir.

Rodillo reticular: el rodillo reticular realiza un fino desmoronamiento de los terrones superficiales del suelo y una compactación ideal para la preparación de la cama de sementera.

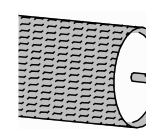
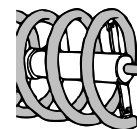
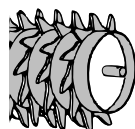
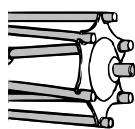
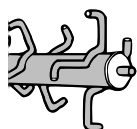
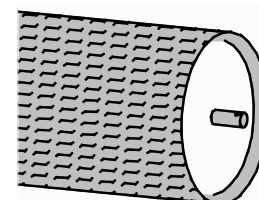

IONIO	ø 48	ø 32	-	-	ø 42
TIRRENO	ø 48	ø 32	ø 37	ø 38	ø 42
ADRIATICO	ø 48	ø 43	ø 48	ø 47	-
ARTICO	ø 48	ø 43	ø 48	ø 47	-
ANTARTICO	ø 55	ø 49	ø 48	ø 47	-
INDIANO	ø 48	ø 43	ø 48	ø 47	-
ATLANTICO	ø 55	ø 49	ø 48	ø 47	-
PACIFICO	ø 55	ø 49	ø 48	ø 47	-



www.bertima.it



IONIO



TIRRENO



ADRIATICO



ARTICO



ANTARTICO



INDIANO



ATLANTICO



PACIFICO

Le illustrazioni e i dati del presente catalogo sono indicative e non vincolanti per il costruttore. • All pictures and data above are indicative only and not binding for the manufacturer. • Alle in diesem Katalog enthaltenen Angaben und Zeichnungen sind annahmend und unverbindlich. • Toutes les données insérées dans ce catalogue ont été indiquées seulement à titre de renseignement. • Las fotografías y los datos mostrados son meramente indicativos y podrían ser variados sin previo aviso por el fabricante.



BERTI
MACCHINE AGRICOLE



Via Musi, 1/A-3 - 37042 Caldiero (VR) ITALY
Tel. +39.045.6139711 - Fax +39.045.6150251
info@bertima.it



MADE IN ITALY

D007.15 rev.01