







BERLI[®]
MACCHINE AGRICOLE

**EKR
EKR/M
EKR/S
TBM
TBM/S
DUAL
XPRO
XPRO/F**



-  **Trinciatrici per aree verdi e terreni incolti per trattori da 30 a 250 HP**
-  **Mulchers for green areas and uncultivated fields for tractors from 30 to 250 HP**
-  **Mulchgeräte für Brachlandpflege für Traktoren von 30 bis 250 PS**
-  **Broyeurs pour espaces verts et terrains incultes pour tracteurs de 30 a 250 CV**
-  **Trituradoras para areas verdes y terrenos no cultivados para tractores de 30 a 250 CV**



L'esperienza di 60 anni nel settore delle macchine agricole permette alla ditta Berti di offrire alla sua vasta clientela una gamma completa di attrezzature tecnologicamente avanzate al servizio di un'agricoltura sempre più esigente e specializzata. La qualità dei prodotti fin dalla materia prima, la volontà di soddisfare sempre e prima di tutto le esigenze della clientela, la robustezza, l'affidabilità, hanno dato vita al largo consenso che queste macchine hanno ricevuto in tutto il mondo.



The experience of 60 years in the manufacturing manufacturing of farm implements makes it possible for Berti Company to offer a complete range of technologically advanced mulchers and shredders, to serve a more and more demanding and specialized agriculture.

The high quality, the sturdiness and the reliability of the products, the will to satisfy always the customer's requirement are the reasons of the large success enjoyed by these implements worldwide.





Die Firma Berti hat 60 Jahre Erfahrung auf dem Gebiet der Landwirtschaftsmaschinen und ist also imstande, ihren zahlreichen Kunden eine komplette Palette von technologisch fortgeschrittenen Landwirtschaftsausrüstungen zu Verfügung zu stellen.

Die Produktqualität, gekennzeichnet durch die Wahl von Rohstoffen erster Klasse, die Beständigkeit und die Zuverlässigkeit der Maschinen, hat die Firma in die Lage gesetzt, diese in der ganzen Welt einzusetzen.



L'expérience acquise au cours de 60 ans de la machine agricole permet à la firme Berti d'offrir à ses nombreux clients une gamme complète d'équipements technologiquement à l'avant-garde au service

d'une agriculture exigeante et professionnelle. La qualité des produits à partir de la matière première, la volonté de satisfaire surtout les exigences de la clientèle, la résistance et la fiabilité ont permis à nos machines d'obtenir un accueil très favorable dans le monde entier.



La experiencia de 60 años en el sector de las máquinas agrícolas ha permitido a la empresa Berti ofrecer a sus clientes una gama completa de equipos tecnológicamente avanzados para una agricultura cada vez más especializada. Gracias a la robustez y a la fiabilidad de los productos y a una calidad que se busca incluso en las materias primas empleadas, unido a la voluntad de satisfacer siempre y en primer lugar las exigencia de los clientes, Berti se ha hecho famosa en todo el mundo.

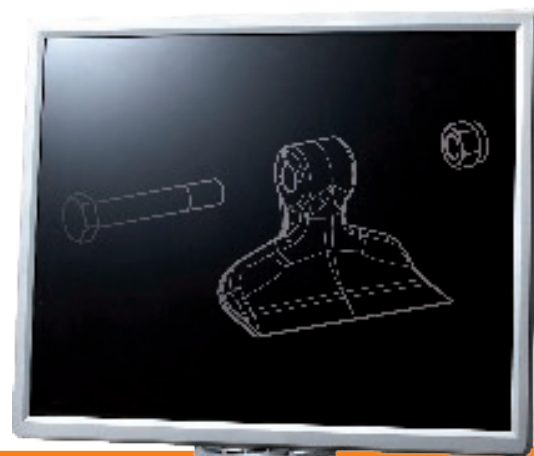



Trinciatrice compatta reversibile applicabile in posizione frontale o posteriore al trattore oppure su trattori con guida retroversa. Per trattori con potenze comprese tra 30 e 70 HP. Consigliata per la trinciatura di erba cespugli rovi e ramaglia fino a Ø 2-3 cm. È ideale in generale per la pulizia di campi aperti, set-aside, e su vigneti.



Broyeur réversible pour tracteurs de 30 à 70 CV. Il est indiqué pour broyer l'herbe, les buissons, et les sarments allant jusqu'à Ø 2-3 cm; il est idéal pour le nettoyage général des champs ouverts ou des vignobles ou pour des applications similaires.













Front and rear compact mulcher to fit tractors from 30 to 70 HP. Suited to mulch grass, bushes, scrub and pruning up to Ø 2-3 cm, it is ideal for general clearing of open field, set aside purposes and on vineyards.



Trituradora compacta reversible aplicable en posición frontal o posterior al tractor o en tractores con conducción invertida. Para tractores con potencias comprendidas entre 30 y 70 HP. Recomendada para el triturado de yerba, arbustos zarzamosas y ramaje hasta Ø 2-3 cm. Es ideal en general para la limpieza de campos abiertos, set-aside, y viñedos.



Heck und Frontanbau Gerät für Gras, Stillelegung und Reisig bis Ø 2-3 cm, für Traktoren von 30 bis 70 PS. Es eignet sich für Brachlandpflege, Wiesen, Gründüngung und Obstanlagen.

Mod.													
	cm	Min	Max	mm	n°	n°	n°	PTO	A	B	C	min	max
EKR 115	115	30	55	430 720	10	30	2	540 (1000)	73	127	78	285	340
EKR 125	125	30	55	615 635	12	36	3	540 (1000)	73	137	78	300	355
EKR 135	135	30	55	615 735	12	36	3	540 (1000)	73	147	78	315	370
EKR 145	145	40	55	615 835	14	42	3	540 (1000)	73	157	78	330	380
EKR 160	160	40	55	715 885	14	42	3	540 (1000)	73	172	78	360	400
EKR 180	180	50	70	780 1020	16	48	4	540 (1000)	75	195	78	480	520
EKR 200	200	50	70	950 1050	18	54	4	540 (1000)	75	215	78	520	560



- Attacco ai tre punti fisso e reversibile, Cat. I-II e tirante fisso al terzo punto.
- Fixed and reversible 3-point linkage, Cat. I-II and top link tie rod
- Fester und umkehrbarer Dreipunktbock, Kat. I-II und oberlenker feste Zugstange.
- Attelage fixe et réversible à 3 points, Cat. I-II et tige de renfort au troisième point.
- Enganche a los tres puntos fijo y reversible, Cat. I-II y tirante fijo en el tercer punto.



- Rullo posteriore autopulente Ø 139 mm., regolabile in altezza (Ø159 EKR 180-200).
- Self-cleaning and adjustable Ø 139 rear roller (Ø159 EKR 180-200).
- Einstellbare, selbstreinigende Stützwalze Ø 139 (Ø159 EKR 180-200).
- Rouleau palpeur autonettoyant Ø 139, réglable en hauteur (Ø159 EKR 180-200).
- Rodillo posterior autolimpiante Ø 139 mm., regulable en altura (Ø159 EKR 180-200).



- Scatola ingranaggi con albero passante e ruota libera.
- Through-shaft and free wheel in the gearbox.
- Getriebe mit Durchtrieb und Freilauf.
- Boîtier avec arbre de sortie arrière et roue libre.
- Caja de transmisión con eje cardan passante y rueda libre.

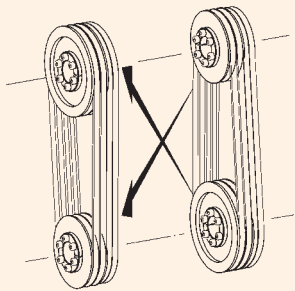

- PTO 540/1000 g/min (invertendo le pulegge).
- PTO 540/1000 rpm (reversing the pulleys).
- Getriebe 540 oder 1000 U/min (Umkehrbare Riemenscheibe).
- PDF 540/1000 t/min (en inversant les poulies).
- PTO 540/1000 g/min (invirtiendo las poleas).



EKR 115→160



EKR 180→200

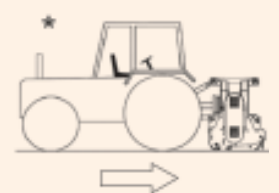
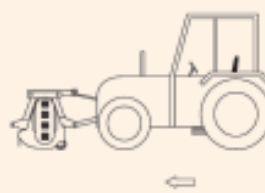
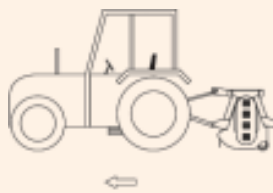
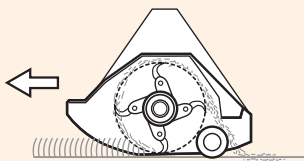

- * Solo con scatola ingranaggi con doppia ruota libera • Gearbox with double free wheel (mandatory)
- Getriebe mit doppeltem Freilauf (bindend) • Double roue libre dans le boîtier (obligatoire)
- Doble rueda libre en la caja de transmisión (obligatorio).

OPTIONALS



- Scatola ingranaggi con doppia ruota libera.
- Gearbox with double free wheel.
- Getriebe mit doppeltem Freilauf.
- Double roue libre dans le boîtier.
- Doble rueda libre en la caja de transmisión.



- Slitte d'appoggio antiusura.
- Skids of anti-wearing steel.
- Satz Kufen mit Anti-Verschleißmaterial.
- Jeu patins anti-usure.
- Patines de acero reforzado anti-desgaste.



- Albero cardanico.
- Pto drive shaft.
- Gelenkwelle.
- Arbre cardan.
- Cardan.

EKR/M



Trinciatrice compatta applicabile in posizione frontale al trattore o posteriore per uso in spinta su trattori a guida retroversa con potenza compresa tra 50 e 90 HP.
Consigliata per la trinciatura di erba, cespugli, rovi e ramaglia fino a Ø 4-5 cm. È ideale in genere per la pulizia di aree verdi, bordi stradali, vigneti e frutteti.



Front-use mulcher to fit tractors from 50 to 90 HP.
Suited to mulch grass, bushes, scrub and pruning (up to Ø 4-5 cm.). It is ideal for general clearing of green areas, road sides, steep slopes, vineyards and orchards.



Frontanbau Gerät für Gras, Stillelegung und Reisig bis 4-5 cm. Ø, für Sonder-Spurtraktoren und Geräteträger von 50 bis 90 PS. Es eignet sich für Wiesen, Gründüngung und Obstanlagen.



Broyeur seulement avant pour tracteurs de 50 à 90 HP.
Il est indiqué pour broyer l'herbe, les buissons, le matériel ligneux et les sarments jusqu'à Ø 4-5 cm. ; il est idéal pour le nettoyage général des espace verts ou des vignobles et pour des applications similaires.



Trituradora compacta aplicable en posición frontal al tractor o posterior para uso en empuje en tractores de conducción invertida con potencia comprendida entre 50 y 90 HP. Recomendada para el triturado de yerba, arbustos, zarzamoras y ramaje hasta Ø 4-5 cm. Es ideal en general para la limpieza de áreas verdes, bordes de carreteras, viñedos y huertos frutales.

Mod.													
	cm	Min	Max	mm	n°	n°	PTO	A	B	C	min	max	
EKR/M 180	180	50	90	1020 780	16	48	4	540 (1000)	80	200	90	460	525
EKR/M 200	200	50	90	1050 950	18	54	4	540 (1000)	80	220	90	510	575



- Attacco ai 3 punti fisso, Cat. I-II.
- Fixed three points linkage, Cat. I-II.
- Fester Dreipunktbock, Kat. I-II.
- Attelage fixe à 3 points, Cat. I-II.
- Enganche fijo a los 3 puntos, Cat. I-II.



- Rullo posteriore autopulente Ø 159 mm., regolabile in altezza.
- Self-cleaning and adjustable Ø 159 rear roller.
- Einstellbare, selbstreinigende Stützwalze Ø 159
- Rouleau palpeur autonettoyant Ø 159, réglable en hauteur.
- Rodillo posterior autolimpiante Ø 159 mm., regulable en altura.



- Scatola ingranaggi con doppia ruota libera.
- Double free wheel in the gearbox.
- Getriebe mit doppeltem Freilauf.
- Boîtier avec double roue libre.
- Caja de transmisión con doble rueda libre.

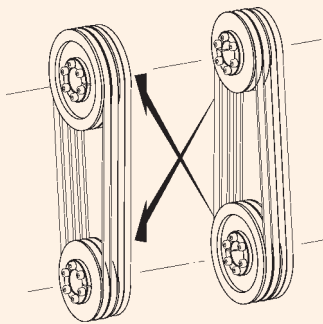

- PTO 540/1000 g/min (invertendo le pulegge).
- PTO 540/1000 rpm (reversing the pulleys).
- Getriebe 540 oder 1000 U/min (Umkehrbare Riemenscheibe).
- PDF 540/1000 t/min (en inversant les poulies).
- PTO 540/1000 g/min (invirtiendo las poleas).

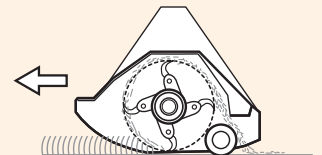

OPTIONALS



- Slitte d'appoggio antiusura.
- Skids of anti-wearing steel.
- Satz Kufen mit Anti-Verschleißmaterial.
- Jeu patins anti-usure.
- Patines de acero reforzado anti-desgaste.



- Albero cardanico.
- Pto drive shaft.
- Gelenkwelle.
- Arbre cardan.
- Cardan.

EKR/S

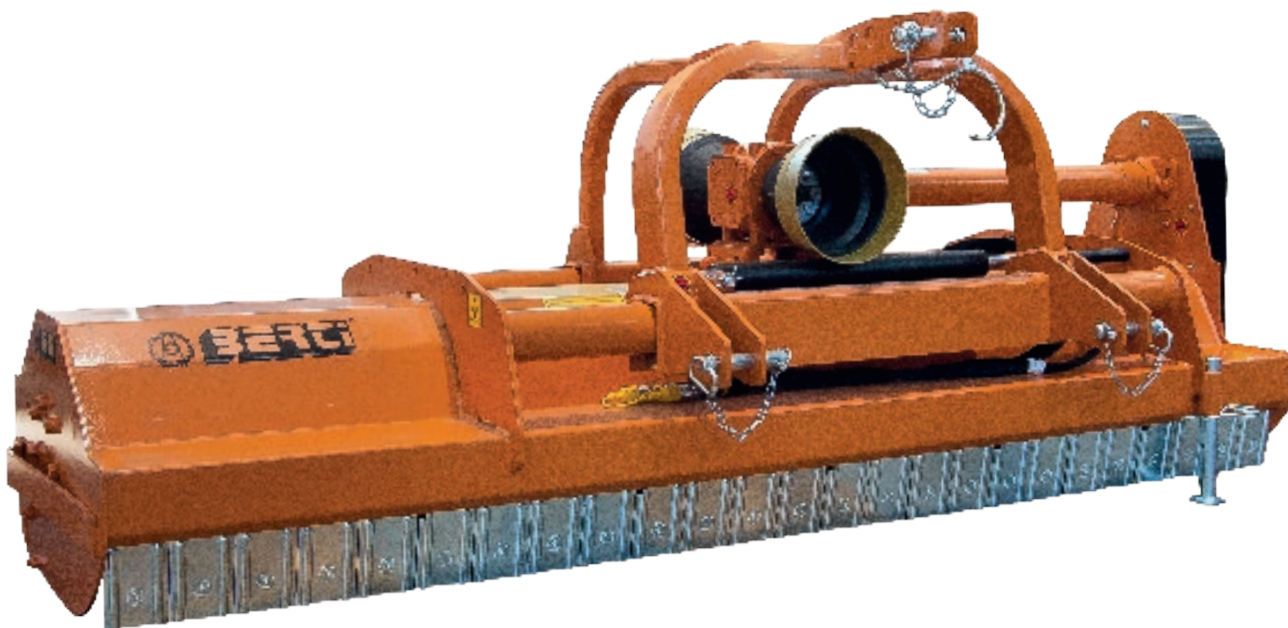

Trinciatrice reversibile applicabile in posizione frontale o posteriore al trattore oppure su trattori con guida retroversa. Da applicare a trattori con potenze comprese tra 50 e 130 HP. Consigliata per la trinciatura di erba cespugli rovi e ramaglia fino a Ø 4-5 cm. E' ideale in generale per la pulizia di campi aperti, set-aside e su vigneti.



Broyeur réversible pour tracteurs de 50 à 130 HP. Il est indiqué pour broyer l'herbe, les buissons, le matériel ligneux et les sarments jusqu'à Ø 4-5 cm; il est idéal pour le nettoyage général des champs ouverts ou des vignobles et pour des applications similaires.



Front and rear mulcher to fit tractors from 50 to 130 HP. Suited to mulch grass, bushes, scrub and pruning up to Ø 4-5 cm., it is ideal for general clearing of open field, set aside purposes and on vineyards.



Trituradora reversible aplicable en posición frontal o posterior al tractor o en tractores con conducción invertida. De aplicar a tractores con potencias comprendidas entre 50 y 130 HP. Recomendada para el triturado de yerba, arbustos zarzamosas y ramaje hasta Ø 4-5 cm. Es ideal en general para la limpieza de campos abiertos, set-aside, y viñedos.



Heck und Frontanbau Gerät mit Seitenverschiebung für Gras, Stilllegung und Reisig bis Ø 4-5 cm, für Traktoren von 50 bis 130 PS. Es eignet sich für Brachlandpflege, Wiesen, Gründüngung und Obstanlagen.

Mod.													
	cm	Min HP	Max HP	mm	n°	n°	n°	PTO	A	B	C	min KG	max KG
EKR/S 180	180	50	100	1040 760 520 1280	16	48	4	540 (1000)	96	198	100	560	710
EKR/S 200	200	50	100	1210 790 690 1310	18	54	4	540 (1000)	96	218	100	600	740
EKR/S 220	220	60	100	1320 880 800 1400	20	60	4	540 (1000)	96	238	100	630	770
EKR/S 250	250	60	130	1320 1180 800 1700	22	66	4	540 (1000)	98	268	100	690	830
EKR/S 270	270	70	130	1610 1090 1090 1610	24	72	4	540 (1000)	101	288	105	860	1000
EKR/S 285	285	70	130	1610 1240 1040 1760	26	78	4	540 (1000)	101	303	105	890	1030
EKR/S 300	300	70	130	1610 1390 1040 1960	28	84	4	540 (1000)	101	318	105	920	1060



- Attacco a tre punti reversibile e spostabile meccanicamente, Cat. II.
- Displaceable and reversible 3-point linkage, Cat. II. (mechanical).
- Umkehrbarer und versetzbarer Dreipunktbock, Kat. II (mechanischer).
- Attelage déportable et réversible à 3 points, Cat. II (mécanique).
- Enganche a los 3 puntos desplazable y reversible, Cat. II (mecánico).



- Rullo posteriore autopulente Ø 159 mm., regolabile in altezza (Ø194 EKR/S 270-300).
- Self-cleaning and adjustable Ø 159 rear roller (Ø194 EKR/S 270-300).
- Einstellbare, selbstreinigende Stützwalze Ø 159 (Ø194 EKR/S 270-300).
- Rouleau palpeur autonettoyant Ø 159, réglable en hauteur (Ø194 EKR/S 270-300).
- Rodillo posterior autolimpiante Ø 159 mm., regulable en altura (Ø194 EKR/S 270-300).



- Scatola ingranaggi con albero passante e ruota libera.
- Through-shaft and free wheel in the gearbox.
- Getriebe mit Durchtrieb und Freilauf.
- Boîtier avec arbre de sortie arrière et roue libre.
- Caja de transmisión con eje cardan passante y rueda libre.

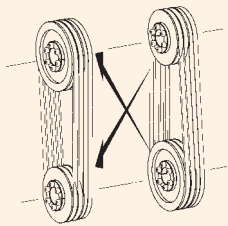

- PTO 540/1000 g/min (invertendo le pulegge).
- PTO 540/1000 rpm (reversing the pulleys).
- Getriebe 540 oder 1000 U/min (Umkehrbare Riemenscheibe).
- PDF 540/1000 t/min (en inversant les poulies).
- PTO 540/1000 g/min (invirtiendo las poleas).



- * Solo con scatola ingranaggi con doppia ruota libera.
- Gearbox with double free wheel (mandatory).
- Getriebe mit doppeltem Freilauf (bindend).
- Double roue libre dans le boîtier (obligatoire).
- Doble rueda libre en la caja de transmisión (obligatorio).

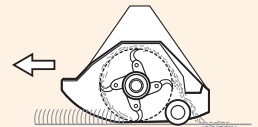

OPTIONALS



- Spostamento idraulico con tubi e innesti rapidi.
- Hydraulic side shift with hoses and quick couplings.
- Hydraulische Seitenverschiebung mit Schnellkupplungen.
- Déport hydraulique avec tuyaux et prises rapides.
- Desplazamiento lateral de accionamiento hidráulico.



- Kit segnaletica stradale con luci.
- Set road-warning panels with lights.
- Satz Warntafel mit Beleuchtung.
- Kit de signalisation avec système d'éclairage.
- Kit de señalización de carretera con luces.

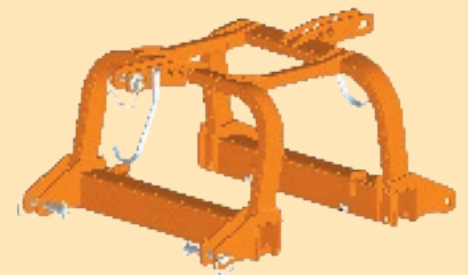

- Doppio attacco ai tre punti.
- Double 3-points linkage.
- Doppelter Dreipunktbock.
- Double attelage à 3 points.
- Doble enganche a los 3 puntos.



- Scatola ingranaggi con doppia ruota libera.
- Gearbox with double free wheel.
- Getriebe mit doppeltem Freilauf.
- Double roue libre dans le boîtier.
- Doble rueda libre en la caja de transmisión.



- Slitte d'appoggio antiusura.
- Skids of anti-wearing steel.
- Satz Kufen mit Anti-Verschleißmaterial.
- Jeu patins anti-usure.
- Patines de acero reforzado anti-desgaste.



- Albero cardanico.
- Pto drive shaft.
- Gelenkwelle.
- Arbre cardan.
- Cardan.

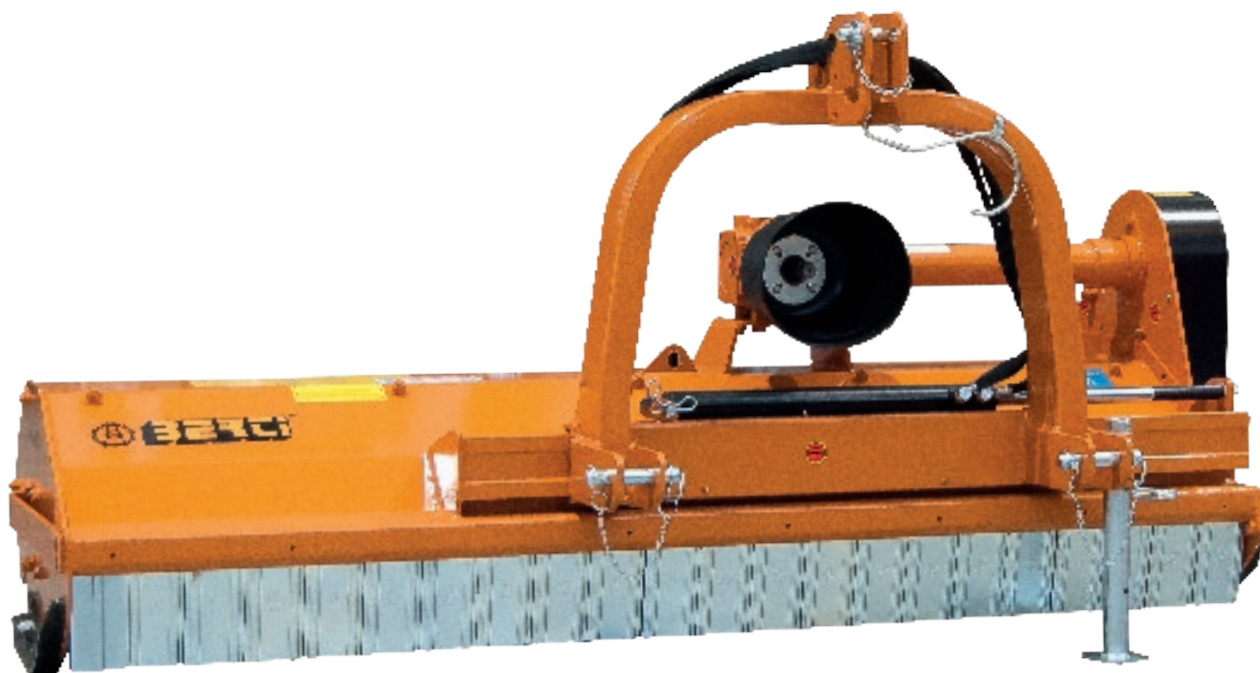

STRENX®
PERFORMANCE STEEL



Trinciatrice da applicare a trattori con potenza compresa tra 50 a 110 HP. È consigliata per trinciare erba, cespugli, rovi stocchi di mais e ramaglia in generale fino a Ø 5-7 cm. Ideale in generale per applicazioni su manutenzione del verde, set-aside, parchi, aree verdi e vigneti.



Mulcher, rear mounted, to fit tractors from 50 to 110 HP. It is suited to mulch grass, bushes, maize stalks, corn stalks, scrub and pruning up to Ø 5-7 cm., ideal for general clearing of open-field crops, green areas, parks, gardens, vineyards and for set aside applications.



Gerät für Gras, Stilllegung, Stroh und Reisig bis Ø 5-7 cm., für Traktoren von 50 bis 110 PS. Es eignet sich für Brachlandpflege, Wiesen, Gründüngung und Obstanlagen.



Broyeur postérieur pour tracteurs de 50 à 110 CV. Il est indiqué pour broyer l'herbe, les buissons, les tiges de maïs et de céréales, et les sarments allant jusqu'à Ø 5-7 cm. Il est idéal pour les nettoyages généraux des cultures en champs ouverts, des espaces verts, des parcs, des jardins, des vignobles ou pour des applications similaires.



Trituradora de aplicar a tractores con potencias comprendidas entre 50 y 110 HP. Está recomendada para triturar yerba, arbustos, zorzamos, tallos de maíz y ramaje en general hasta Ø 5-7 cm. Ideal en general para aplicaciones en mantenimiento del verde, set-aside, parques, áreas verdes y viñedos.

Mod.													
	cm	Min	Max	mm	n°	n°	n°	PTO	A	B	C	min	max
TBM 180	180	50	110	875 925 355 1445	16	48	4	540 (1000)	100	198	100	735	815
TBM 200	200	50	110	1040 960 520 1480	18	54	4	540 (1000)	100	218	100	780	870
TBM 220	220	60	110	1040 1160 520 1680	20	60	4	540 (1000)	100	238	100	820	920
TBM 250	250	60	110	1040 1460 520 1980	22	66	4	540 (1000)	115	268	100	905	1025
TBM 270	270	60	110	1040 1660 520 2180	24	72	4	540 (1000)	115	288	100	935	1070



- Attacco ai 3 punti spostabile meccanicamente, Cat. II.
- Displaceable three points linkage, Cat. II (mechanical).
- Versetzbarer Dreipunktbock, Kat. II (mechanischer).
- Attelage deportable à 3 points, Cat. II (mécanique).
- Enganche desplazable a los 3 puntos Cat. II (mecánico).

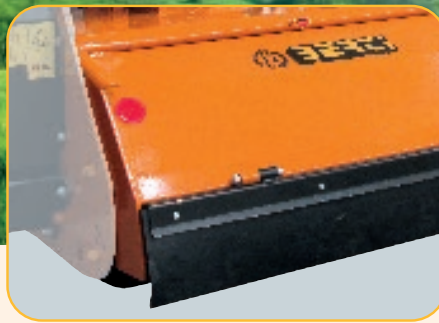

- Rullo posteriore autopulente Ø 194 mm., regolabile in altezza.
- Self-cleaning and adjustable Ø 194 rear roller.
- Einstellbare, selbstreinigende Stützwalze Ø 194.
- Rouleau palpeur autonettoyant Ø 194, réglable en hauteur.
- Rodillo posterior autolimpiante Ø 194 mm., regulable en altura.



- Tenditore automatico delle cinghie.
- Full automatic belts adjuster.
- Automatische Riemenspannung.
- Tendeur automatique des courroies.
- Tensor automático de las correas.



- Slitte d'appoggio antiusura.
- Skids of anti-wearing steel.
- Satz Kufen mit Anti-Verschleißmaterial.
- Jeu patins anti-usure.
- Patines de acero reforzado anti-desgaste.

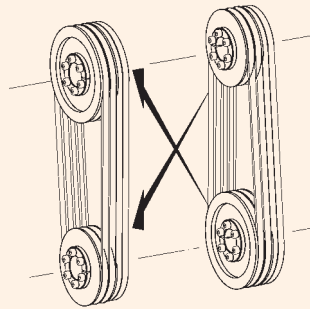

- PTO 540/1000 g/min (invertendo le pulegge).
- PTO 540/1000 rpm (reversing the pulleys).
- Getriebe 540 oder 1000 U/min (Umkehrbare Riemenscheibe).
- PDF 540/1000 t/min (en inversant les poulies).
- PTO 540/1000 g/min (invertiendo las poleas).

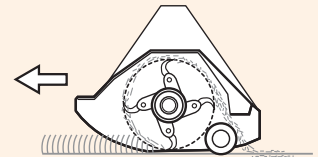
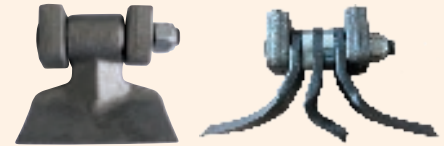

OPTIONALS



- Spostamento idraulico con tubi e innesti rapidi.
- Hydraulic side shift with hoses and quick couplings.
- Hydraulische Seitenverschiebung mit Schnellkupplungen.
- Déport hydraulique avec tuyaux et prises rapides.
- Desplazamiento lateral de accionamiento hidráulico.



- Kit segnaletica stradale con luci.
- Set road-warning panels with lights.
- Satz Warntafel mit Beleuchtung.
- Kit de signalisation avec système d'éclairage.
- Kit de señalización de carretera con luces.



- Attacco centrale.
- Centre mounted linkage.
- Mittlerer Anbau.
- Attelage axial.
- Enganche central.

Mod.	mm	
TBM 250	1355	1145
	833	1667
TBM 270	1587	1113
	1065	1635



- Ruote sterzanti.
- Steering wheels.
- Hinterlenkräder.
- Roues directrices.
- Ruedas directrices.



- Pulirullo.
- Roller scraper.
- Satz Walzenabstreifer.
- Décrotoir à rouleau.
- Polirodillo.



- Albero cardanico.
- Pto drive shaft.
- Gelenkwelle.
- Arbre cardan.
- Cardan.

TBM/S



STRENX®
PERFORMANCE STEEL



Trinciatrice da applicare a trattori con potenza compresa tra 75 a 150 HP. E' consigliata per trinciare erba, cespugli, rovi stocchi di mais e ramaglia in generale fino a Ø 6-8 cm. Ideale in generale per applicazioni su manutenzione del verde, set-aside, parchi, aree verdi e vigneti.



Heavy duty mulcher, rear mounted, to fit tractors from 75 to 150 HP. It is suited to mulch grass, bushes, maize stalks, corn stalks, sun-flowers, gorse, scrub and pruning up to Ø 6-8 cm., ideal for general clearing of uncultivated fields, open-field crops, green areas, under wood, parks, gardens, and for set aside applications.



Gerät für Gras, Stillegung, Stroh, Reisig und Äste bis Ø 6-8 cm. für Traktoren von 75 bis 150 PS. Es eignet sich für Brachlandpflege, Wiesen, Gründüngung und Obstanlagen.



Broyeur postérieur renforcé pour tracteurs de 75 à 150 CV. Il est indiqué pour broyer l'herbe, les buissons, les tiges de maïs et de céréales, les tournesols, les ronces, et les sarments allant jusqu'à Ø 6-8 cm; idéal pour les nettoyages généraux sur des terrains incultes, des cultures en champs ouverts, des espaces verts, du sous-bois, des parcs et des jardins ou pour des applications similaires.



Trituradora de aplicar a tractores con potencia comprendida entre 75 y 150 HP. Está recomendada para triturar yerba, arbustos, zarcamoras, tallos de maíz y ramaje en general hasta a Ø 6-8 cm. Ideal en general para aplicaciones en mantenimiento del verde, set-aside, parques, áreas verdes y viñedos.

Mod.													
	cm	Min	Max	mm	n°	n°	n°	PTO	A	B	C	min	max
TBM/S 180	180	75	150	875 925 355 1445	16	48	5	1000 (540)	100	198	105	845	955
TBM/S 200	200	75	150	1040 960 520 1480	18	54	5	1000 (540)	100	218	105	890	1020
TBM/S 220	220	75	150	1040 1160 520 1680	20	60	5	1000 (540)	100	238	105	935	1080
TBM/S 250	250	75	150	1040 1460 520 1980	22	66	5	1000 (540)	100	268	105	1000	1160
TBM/S 270	270	85	150	1040 1660 520 2180	24	72	5	1000 (540)	100	288	105	1055	1220
TBM/S 285	285	85	150	1040 1810 520 2330	26	78	5	1000 (540)	100	303	105	1100	1270
TBM/S 300	300	85	150	1040 1960 520 2480	28	84	5	1000 (540)	100	318	105	1135	1310



- Attacco ai 3 punti spostabile meccanicamente, Cat. II.
- Displaceable three points linkage, Cat. II (mechanical).
- Versetzbarer Dreipunktbock, Kat. II (mechanischer).
- Attelage deportable à 3 points, Cat. II (mécanique).
- Enganche desplazable a los 3 puntos Cat. II (mecánico).



- Rullo posteriore autopulente Ø 194 mm., regolabile in altezza.
- Self-cleaning and adjustable Ø 194 rear roller.
- Einstellbare, selbstreinigende Stützwalze Ø 194.
- Rouleau palpeur autonettoyant Ø 194, réglable en hauteur.
- Rodillo posterior autolimpiante Ø 194 mm., regulable en altura.



- Tenditore automatico delle cinghie.
- Full automatic belts adjuster.
- Automatische Riemenspannung.
- Tendeur automatique des courroies.
- Tensor automático de las correas.



- Slitte d'appoggio antiusura.
- Skids of anti-wearing steel.
- Satz Kufen mit Anti-Verschleißmaterial.
- Jeu patins anti-usure.
- Patines de acero reforzado anti-desgaste.

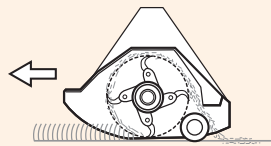

- Attacco centrale.
- Centre mounted linkage.
- Mittiger Anbau.
- Attelage axial.
- Enganche central.

OPTIONALS



- Spostamento idraulico con tubi e innesti rapidi.
- Hydraulic side shift with hoses and quick couplings.
- Hydraulische Seitenverschiebung mit Schnellkupplungen.
- Déport hydraulique avec tuyaux et prises rapides.
- Desplazamiento lateral de accionamiento hidráulico.



- Kit segnaletica stradale con luci.
- Set road-warning panels with lights.
- Satz Warntafel mit Beleuchtung.
- Kit de signalisation avec système d'éclairage.
- Kit de señalización de carretera con luces.



- Ruote sterzanti.
- Steering wheels.
- Hinterlenkräder.
- Roues directrices.
- Ruedas directrices.



- Pulirullo.
- Roller scraper.
- Satz Walzenabstreifer.
- Décrottoir à rouleau.
- Polirodillo.

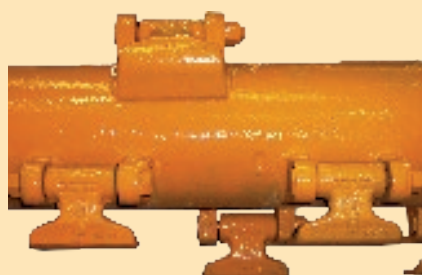

- Rotore Mega.
- Rotor type Mega.
- Rotor Typ Mega.
- Rotor type Mega.
- Rotor tipo Mega.



- Albero cardanico.
- Pto drive shaft.
- Gelenkwelle.
- Arbre cardan.
- Cardan.

Mod.	mm	
		1616
TBM/S 270	1094	1756
TBM/S 285	1616	1234
	1094	1756
TBM/S 300	1616	1384
	1094	1906

DUAL





STRENX®
PERFORMANCE STEEL









 Trinciatrice reversibile applicabile in posizione frontale o posteriore al trattore oppure su trattori con guida retroversa. Da applicare a trattori con potenze comprese tra 70 e 160 HP. Consigliata per la trinciatura di erba cespugli rovi stocchi di mais e ramaglia fino a Ø 6-8 cm è idea-le in generale per la pulizia di parchi, aree verdi, set-aside.

 Front and rear mulcher to fit tractors from 70 to 160 HP. It is suited to mulch grass, bushes, maize stalks, corn stalks, sunflowers, scrub and pruning up to Ø 6-8 cm., ideal for general clearing of open-field crops, green areas, parks, gardens, and for set aside applications.

 Front- und Heckanbau Gerät mit Seitenverschiebung, für Gras, Stillelegung, Stroh und Reisig bis Ø 6-8 cm. Es eignet sich für Brachlandpflege, Wiesen, Gründüngung und Obstanlagen, für Traktoren von 70 bis 160 PS.

 Broyeur réversible pour tracteurs de 70 à 160 CV. Il est indiqué pour broyer l'herbe, les buissons, les tiges de maïs et de céréales, les tournesols, et les sarments allant jusqu'à Ø 6-8 cm; idéal pour les nettoyages généraux des cultures en champs ouverts, des espaces verts, du sous-bois, des parcs et des jardins ou pour des applications similaires.

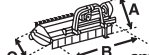
 Trituradora reversible aplicable en posición frontal o posterior al tractor o en tractores con conducción invertida. De aplicar a tractores con potencias comprendidas entre 70 y 160 HP. Recomendada para el triturado de yerba, arbustos, zarzamosas, tallos de maíz y ramaje hasta Ø 6-8 cm es ideal en general para la limpieza de parques, áreas verdes, set-aside.

Mod.													
	cm	Min	Max						mm	n°	n°	n°	A
DUAL 200	200	70	160	1040 960 520 1480	18	54	4	1000 (540)	105	220	120	875	975
DUAL 230	230	70	160	1320 980 800 1500	20	60	4	1000 (540)	105	250	120	940	1040
DUAL 250	250	70	160	1320 1180 800 1700	22	66	4	1000 (540)	105	270	120	990	1090
DUAL 285	285	70	160	1610 1240 1090 1760	26	78	4	1000 (540)	105	305	120	1070	1170
DUAL 300	300	70	160	1610 1390 1090 1910	28	84	4	1000 (540)	105	320	120	1110	1210



- Doppio attacco ai tre punti centrale e spostabile meccanicamente, Cat. II.
- Double and displaceable 3-point linkage, centre mounted, Cat. II (mechanical).
- Versetzbarer, doppelter und mittiger Dreipunktbock, Kat. II (mechanischer).
- Double attelage axial et deportable à 3 points, Cat. II (mecanique).
- Doble enganche central y desplazable a los 3 puntos, Cat. II (mecánico).



- Rullo posteriore autopulente Ø 194 mm., regolabile in altezza.
- Self-cleaning and adjustable Ø 194 rear roller.
- Einstellbare, selbstreinigende Stützwalze Ø 194.
- Rouleau palpeur autonettoyant Ø 194, réglable en hauteur.
- Rodillo posterior autolimpiante Ø 194 mm., regulable en altura.



- Slitte d'appoggio antiusura.
- Skids of anti-wearing steel.
- Satz Kufen mit Anti-Verschleißmaterial.
- Jeu patins anti-usure.
- Patines de acero reforzado anti-desgaste.



- Tenditore automatico delle cinghie.
- Full automatic belts adjuster.
- Automatische Riemenspannung.
- Tendeur automatique des courroies.
- Tensor automático de las correas.



- Scatola ingranaggi con albero passante e doppia ruota libera.
- Through-shaft and double free wheel in the gearbox.
- Getriebe mit Durchtrieb und doppeltem Freilauf.
- Boîtier avec arbre de sortie arrière et double roue libre.
- Caja de transmisión con eje cardan passante y doble rueda libre.

OPTIONALS



- Spostamento idraulico con tubi e innesti rapidi.
- Hydraulic side shift with hoses and quick couplings.
- Hydraulische Seitenverschiebung mit Schnellkupplungen.
- Déport hydraulique avec tuyaux et prises rapides.
- Desplazamiento lateral de accionamiento hidráulico.



- Kit molle anteriori per scarico peso.
- Weight relief springs-kit.
- Entlastungsfeder-Satz.
- Kit de ressorts frontales pour du poids.
- Kit de muelles frontales para el descargue del peso.



- Kit segnaletica stradale con luci.
- Set road-warning panels with lights.
- Satz Warntafel mit Beleuchtung.
- Kit de signalisation avec système d'éclairage.
- Kit de señalización de carretera con luces.



- Ruote frontali stabilizzatrici.
- Height adjustable front wheels.
- Front-Stützräder, höhenverstellbare.
- Roues frontales réglables en hauteur.
- Ruedas frontales estabilizadoras.





- Albero cardanico.
- Pto drive shaft.
- Gelenkwelle.
- Arbre cardan.
- Cardan.

XPRO





STRENX®
PERFORMANCE STEEL







 Trinciatrice professionale, rinforzata reversibile applicabile frontalmente o posteriormente o su trattori con guida retroversa con potenza compresa tra 100 e 250 HP. E' consigliata per la trinciatura di erba, paglia, residui vegetali, cespugli, stocchi di mais, sarmenti e residui legnosi fino a Ø 8-10 cm., per la manutenzione di terreni incolti, aree verdi, set-aside.

 Front and rear heavy-duty professional mulcher to fit tractors from 100 to 250 HP. It is suited to mulch grass, bushes, maize stalks, corn stalks, sunflowers, scrub and pruning up to Ø 8-10 cm., ideal for general clearing of uncultivated fields, open-field crops, green areas, parks, gardens, under-wood and for set aside applications.

 Verstärktes- und Vielseitig-, Front/Heck- Mulchgerät, für Traktoren von 100 bis 250 PS. Mulcht Gras, Stilllegung, Sonnenblumen, Maisstroh, Gestrüpp und Reisig bis Ø 8-10 cm. Es eignet sich für Brachlandpflege, Wiesen, Gründüngung, Obstanlagen, Mais, Zuckerrohr, Rüben usw.

 Broyeur professionnel réversible pour tracteurs de 100 à 250 CV. Il est indiqués pour broyer l'herbe, les buissons, les tiges de maïs et de céréales, les tournesols, et les sarments allant jusqu'à Ø 8-10 cm; il est idéal pour le nettoyage général des terrains incultes, des cultures en champs ouverts, des espaces verts, des parcs, des jardins et du sous-bois ou pour des applications similaires.

 Trituradora profesional, reforzada reversible aplicable frontalmente o posteriormente o en tractores con conducción inversa con potencia comprendida entre 100 y 250 HP. Está recomendada para el triturado de yerba, paja, residuos vegetales, arbustos, tallos de maíz, sarmientos y residuos leñosos hasta Ø 8-10 cm., para el mantenimiento de terrenos no cultivados, áreas verdes, set-aside.

Mod.												
	cm	Min	Max	mm	n°	n°	PTO	A	B	C	min	max
XPRO 200	200	100	250	1250 750 730 1270	18	5	1000 (540)	122	220	137	1275	1555
XPRO 230	230	100	250	1320 980 800 1500	20	5	1000 (540)	122	250	137	1355	1645
XPRO 250	250	100	250	1500 1000 980 1520	22	5	1000 (540)	122	270	137	1415	1705
XPRO 285	285	100	250	1610 1240 1090 1760	26	5	1000 (540)	122	305	137	1520	1810
XPRO 300	300	100	250	1610 1390 1090 1910	28	5	1000 (540)	122	320	137	1560	1850



- Doppio attacco ai tre punti centrale, spostabile idraulicamente, Cat. II-III.
- Double and displaceable 3-point linkage, centre mounted, Cat. II-III (hydraulic).
- Versetzbarer, doppelter und mittiger Dreipunktbock, Kat. II-III (Hydraulischer).
- Double attelage axial et deportable à 3 points, Cat. II-III (hydraulique).
- Doble enganche central y desplazable a los 3 puntos, Cat. II-III (hidráulico).



- Tenditore automatico delle cinghie.
- Full automatic belts adjuster.
- Automatische Riemenspannung.
- Tendeur automatique des courroies.
- Tensor automático de las correas.



- Rullo posteriore autopulente Ø 220 mm., regolabile in altezza.
- Self-cleaning and adjustable Ø 220 rear roller.
- Einstellbare, selbstreinigende Stützwalze Ø 220
- Rouleau palpeur autonettoyant Ø 220, réglable en hauteur.
- Rodillo posterior autolimpiante Ø 220 mm., regulable en altura.



- Scatola ingranaggi con albero passante e doppia ruota libera.
- Through-shaft and double free wheel in the gearbox.
- Getriebe mit Durchtrieb und doppeltem Freilauf.
- Boîtier avec arbre de sortie arrière et double roue libre.
- Caja de transmisión con eje cardan passante y doble rueda libre.



- Slitte d'appoggio antiusura.
- Skids of anti-wearing steel.
- Satz Kufen mit Anti-Verschleißmaterial.
- Jeu patins anti-usure.
- Patines de acero reforzado anti-desgaste.



OPTIONALS



- Kit molle anteriori per scarico peso.
- Weight relief springs-kit.
- Entlastungsfeder-Satz.
- Kit de ressorts frontales pour du poids.
- Kit de muelles frontales para el descargue del peso.



- Kit segnaletica stradale con luci.
- Set road-warning panels with lights.
- Satz Warntafel mit Beleuchtung.
- Kit de signalisation avec système d'éclairage.
- Kit de señalización de carretera con luces.

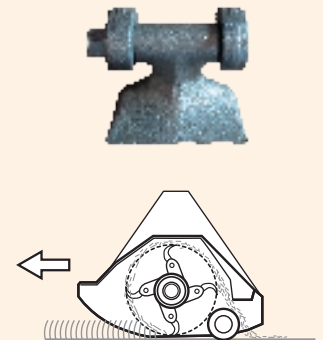

- Pulirullo.
- Roller scraper.
- Satz Walzenabstreifer.
- Décrottoir à rouleau.
- Polirodillo.



- Ruote frontali pivotanti.
- Pivoting front wheels.
- Front- Schwenkräder.
- Roues frontales pivotantes.
- Kit de ruedas frontales pivotantes.





- Albero cardanico.
- Pto drive shaft.
- Gelenkwelle.
- Arbre cardan.
- Cardan.

XPRO/F





STRENX®
PERFORMANCE STEEL















 Trinciatrice professionale, rinforzata reversibile applicabile frontalmente o posteriormente o su trattori con guida retroversa con potenza compresa tra 100 e 250 HP. E' consigliata per la trinciatura di erba, paglia, residui vegetali, cespugli, stocchi di mais, sarmenti e residui legnosi fino a Ø 10-12 cm., per la manutenzione di terreni incolti, aree verdi, set-aside.

 Broyeur professionnel réversible pour tracteurs de 100 à 250 CV. Il est indiqués pour broyer l'herbe, les buissons, les tiges de maïs et de céréales, les tournesols, et les sarments allant jusqu'à Ø 10-12 cm; il est idéal pour le nettoyage général des terrains incultes, des cultures en champs ouverts, des espaces verts, des parcs, des jardins et du sous-bois ou pour des applications similaires.

 Front and rear heavy-duty professional mulcher to fit tractors from 100 to 250 HP. It is suited to mulch grass, bushes, maize stalks, corn stalks, sunflowers, scrub and pruning up to Ø 10-12 cm., ideal for general clearing of uncultivated fields, open-field crops, green areas, parks, gardens, under-wood and for set aside applications.

 Trituradora profesional, reforzada reversible aplicable frontalmente o posteriormente o en tractores con conducción inversa con potencia comprendida entre 100 y 250 HP. Está recomendada para el triturado de yerba, paja, residuos vegetales, arbustos, tallos de maíz, sarmientos y residuos leñosos hasta Ø 10-12 cm., para el mantenimiento de terrenos no cultivados, áreas verdes, set-aside.

 Verstärktes- und Vielseitig-, Front/Heck- Mulchgerät, für Traktoren von 100 bis 250 PS. Mulcht Gras, Stilllegung, Sonnenblumen, Maisstroh, Gestrüpp und Reisig bis Ø 10-12 cm. Es eignet sich für Brachlandpflege, Wiesen, Gründüngung, Obstanlagen, Mais, Zuckerrohr, Rüben usw.

Mod.												
	cm	Min	Max	mm	n°	n°	PTO	A	B	C	min	max
XPRO/F 200	200	100	250		18	5	1000 (540)	122	220	144	1320	1600
XPRO/F 230	230	100	250		20	5	1000 (540)	122	250	144	1410	1700
XPRO/F 250	250	100	250		22	5	1000 (540)	122	270	144	1475	1765
XPRO/F 285	285	100	250		26	5	1000 (540)	122	305	144	1585	1875
XPRO/F 300	300	100	250		28	5	1000 (540)	122	320	144	1630	1920



- Doppio attacco ai tre punti centrale, spostabile idraulicamente, Cat. II-III.
- Double and displaceable 3-point linkage, centre mounted, Cat. II-III (hydraulic).
- Versetzbarer, doppelter und mittiger Dreipunktbock, Kat. II-III (Hydraulischer).
- Double attelage axial et deportable à 3 points, Cat. II-III (hydraulique).
- Doble enganche central y desplazable a los 3 puntos, Cat. II-III (hidráulico).



- Tenditore automatico delle cinghie.
- Full automatic belts adjuster.
- Automatische Riemenspannung.
- Tendeur automatique des courroies.
- Tensor automático de las correas.



- Rullo posteriore autopulente Ø 220 mm., regolabile in altezza con pulirullo e rastrelli raccoglitori.
- Self-cleaning and adjustable Ø 220 rear roller with scraper and rakes.
- Einstellbare, selbstreinigende Stützwalze Ø 220 mit Abstreifer und Sammelrechen.
- Rouleau palpeur autonettoyant Ø 220, réglable en hauteur avec décrotoir et râteaux ramasseurs.
- Rodillo posterior autolimpiante Ø 220 mm., regulable en altura con polirollo y rastrillos recogedores.



- Scatola ingranaggi con albero passante e doppia ruota libera.
- Through-shaft and double free wheel in the gearbox.
- Getriebe mit Durchtrieb und doppeltem Freilauf.
- Boîtier avec arbre de sortie arrière et double roue libre.
- Caja de transmisión con eje cardan passante y doble rueda libre.



- Slitte d'appoggio antiusura.
- Skids of anti-wearing steel.
- Satz Kufen mit Anti-Verschleißmaterial.
- Jeu patins anti-usure.
- Patines de acero reforzado anti-desgaste.



OPTIONALS



- Kit molle anteriori per scarico peso.
- Weight relief springs-kit.
- Entlastungsfeder-Satz.
- Kit de ressorts frontales pour du poids.
- Kit de muelles frontales para el descargue del peso.



- Kit segnaletica stradale con luci.
- Set road-warning panels with lights.
- Satz Warntafel mit Beleuchtung.
- Kit de signalisation avec système d'éclairage.
- Kit de señalización de carretera con luces.

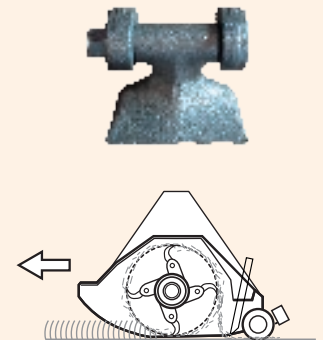

- Ruote frontali pivotanti.
- Pivoting front wheels.
- Front- Schwenkräder.
- Roues frontales pivotantes.
- Kit de ruedas frontales pivotantes.



- Albero cardanico.
- Pto drive shaft.
- Gelenkwelle.
- Arbre cardan.
- Cardan.



bertima.it



EKR



EKR/M



EKR/S

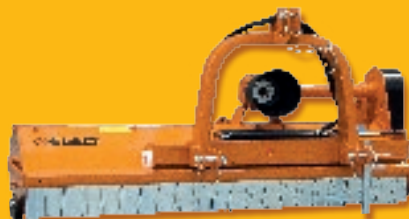

TBM



TBM/S



DUAL



XPRO



XPRO/F

Le illustrazioni e i dati del presente catalogo sono indicative e non vincolanti per il costruttore • All pictures and data above are indicative only and not binding for the manufacturer • Alle in diesem Katalog enthaltenen Angaben und Zeichnungen sind annahmend und unverbindlich • Toutes les données insérées dans ce catalogue ont été indiquées seulement à titre de renseignement • Las fotografías y los datos mostrados son meramente indicativos y podrían ser variados sin previo aviso por el fabricante.



BERTI[®]
MACCHINE AGRICOLE



Via Musi, 1/A-3-4 - 37042 Caldiero (VR) ITALY
Tel. +39.045.6139711 - Fax +39.045.6150251
info@bertima.it



 **MADE IN ITALY**

D016.18 REV03